

NO. F080-869

ISSUED: APR. 25, 2012

REVISED: APR. 25, 2014



**HOSHIZAKI
SELF-CONTAINED ICE MAKER**

**MODEL FM-150KE(-N)
 CM-140KE
 FM-150KE-50(-N)
 FM-120KE
 CM-110KE-50
 FM-80KE(-N)**

SERVICE MANUAL

CONTENTS

PAGE

I. SPECIFICATIONS -----	1
1. DIMENSIONS/SPECIFICATIONS -----	1
[a] FM-150KE -----	1
[b] FM-150KE-N -----	2
[c] CM-140KE -----	3
[d] FM-150KE-50 -----	4
[e] FM-150KE-50-N -----	5
[f] FM-120KE -----	6
[g] CM-110KE-50 -----	7
[h] FM-80KE -----	8
[i] FM-80KE-N -----	9
2. CONSTRUCTION -----	10
[a] FM-150KE(-N), CM-140KE, FM-150KE-50(-N), FM-120KE, CM-110KE-50 -----	10
[b] FM-80KE(-N) -----	11
II. MAINTENANCE AND CLEANING INSTRUCTIONS -----	12
1. EXTRUDING HEAD (UPPER BEARING), HOUSING (LOWER BEARING) -----	12
2. MECHANICAL SEAL -----	12
3. GEAR MOTOR -----	13
4. CONDENSER (AIR-COOLED MODEL ONLY) -----	13
5. AIR FILTER (AIR-COOLED MODEL ONLY) -----	13
6. CONTROL WATER VALVE -----	14
7. CLEANING OF WATER SYSTEM -----	15
III. TECHNICAL INFORMATION -----	18
1. WATER CIRCUIT AND REFRIGERANT CIRCUIT -----	18
[a] FM-150KE(-N), CM-140KE, FM-150KE-50(-N), FM-120KE, CM-110KE-50 -----	18
[b] FM-80KE(-N) -----	19
2. WIRING DIAGRAM -----	20
[a] WIRING DIAGRAM -----	20
[b] CONTROL BOX LAYOUT -----	22
3. ICEMAKING MECHANISM -----	23
[a] EVAPORATOR (CASING) -----	24
[b] AUGER -----	24
[c] EXTRUDING HEAD (BEARING) -----	24
[d] HOUSING -----	24
[e] MECHANICAL SEAL -----	24
[f] COUPLING (SPLINE JOINT) -----	24
[g] GEAR MOTOR -----	24
[h] BELT HEATER -----	25
[i] REMOVABLE FLANGE -----	25
[j] SEALING BOLT -----	25
4. ELECTRIC CIRCUIT -----	26
[a] BASIC OPERATION -----	26
[b] TIMING CHART -----	27
5. OPERATION BOARD -----	28
[a] OPERATION BUTTONS -----	28

[b]	SETTING MODEL NUMBER-----	28
[c]	DISPLAYING COMPRESSOR OPERATING HOURS, CYCLE TIME, MODEL NUMBER AND SOFTWARE VERSION -----	29
[d]	DISPLAYING ERROR LOG -----	31
[e]	RESETTING ERROR LOG -----	32
[f]	RESETTING COMPRESSOR OPERATING HOURS -----	32
[g]	REDUCING COMPRESSOR STARTING TIME-----	32
6.	PROTECTORS -----	33
[a]	INDICATION -----	33
7.	ERROR CODES-----	34
8.	PERFORMANCE DATA -----	36
[a]	FM-150KE, FM-150KE-50 -----	36
[b]	FM-150KE-N, FM-150KE-50-N -----	37
[c]	CM-140KE -----	38
[d]	FM-120KE -----	39
[e]	CM-110KE-50 -----	40
[f]	FM-80KE -----	41
[g]	FM-80KE-N -----	42
IV.	SERVICE DIAGNOSIS -----	43
1.	NO ICE PRODUCTION -----	43
2.	LOW ICE PRODUCTION-----	45
3.	OTHERS-----	45
V.	REMOVAL AND REPLACEMENT -----	47
1.	SERVICE FOR REFRIGERANT LINES -----	47
[a]	SERVICE INFORMATION -----	47
[b]	REFRIGERANT RECOVERY -----	48
[c]	EVACUATION AND RECHARGE-----	48
2.	BRAZING-----	50
3.	COMPRESSOR-----	50
4.	DRIER-----	51
5.	EXPANSION VALVE -----	52
6.	WATER REGULATING VALVE - WATER-COOLED MODEL ONLY -----	53
7.	EVAPORATOR ASSEMBLY -----	54
8.	CONTROL WATER VALVE -----	57
9.	FLUSH WATER VALVE -----	57
10.	CONTROLLER BOARD -----	58
[a]	MODIFICATION -----	58
[b]	REPLACEMENT -----	58

I. SPECIFICATIONS

1. DIMENSIONS/SPECIFICATIONS

[a] FM-150KE

ITEM	HOSHIZAKI FLAKE ICE MAKER
MODEL	FM-150KE
POWER SUPPLY	1 Phase 220-240V 50Hz Capacity: 1.46kVA (6.4A)
AMPERAGE	5.1A Starting: 20A
ELECTRIC CONSUMPTION	640W (Power Factor: 58%)
ICE PRODUCTION PER 24h	Approx. 150kg (Ambient Temp. 10°C, Water Temp. 10°C) Approx. 130kg (Ambient Temp. 21°C, Water Temp. 15°C) Approx. 110kg (Ambient Temp. 32°C, Water Temp. 21°C)
SHAPE OF ICE	Flake
MAX. STORAGE CAPACITY	Approx. 28kg - Leveled (Bin Control Setting Approx. 21kg) Approx. 0.150m ³ (Ambient Temp. 10°C, Water Temp. 10°C) Approx. 0.130m ³ (Ambient Temp. 21°C, Water Temp. 15°C) Approx. 0.110m ³ (Ambient Temp. 32°C, Water Temp. 21°C)
OUTSIDE DIMENSIONS	640mm(W) x 600mm(D) x 800(798~833)mm(H)
INSULATION FOAM BLOWING AGENT	HFC-245fa, 365mfc
HEAT REJECTION	1120W(Ambient temp. 32°C, Water temp. 21°C)
CABINET	Stainless Steel, Galvanized Steel (Rear)
ICE MAKING SYSTEM	Thin ice forming inside Cylinder (Flake Ice)
WATER SUPPLY SYSTEM	Direct Connection to Water Main. Inlet: G3/4 (Rear)
DRAIN SYSTEM	Outlet: R3/4 (Rear)
COMPRESSOR	Hermetic
CONDENSER	Fin and Tube type, Air-cooled
EVAPORATOR	Tube coiled around Cylinder (Solder Plated)
REFRIGERANT	R134a
BIN CONTROL	Actuator and Reed Switch (Time delay controlled)
ICEMAKING WATER CONTROL	Float Switch and Solenoid Valve
ELECTRICAL PROTECTION	10A Circuit Breaker
REFRIGERANT CIRCUIT PROTECTION	Compressor Internal Thermostat Condensing Temperature detected by Thermistor (Auto-reset)
MECHANISM PROTECTION	Micro switch (Manual-reset)
INTERLOCK	Shutdown by Microprocessor (Manual-reset)
WEIGHT	Net: 71kg (Gross 82kg)
PACKAGE	Carton 750(W) x 700(D) x 890mm(H)
ACCESSORIES	Scoop, Installation Kit
OPERATING CONDITIONS	Ambient Temp.: 5 - 40°C, Water Supply Temp.: 5-35°C Water Supply Pressure: 0.05-0.8MPa, Voltage Range: Rated Voltage±10%

*We reserve the right to make changes in specifications and design without prior notice.

1. Install the ice maker properly in accordance with the instructions on location, water supply/drain connections and electrical connections stated in the instruction and installation manuals provided.
2. The ice production depends on the ambient and water temperatures. Refer to the instruction manual.
3. Product Code: F080

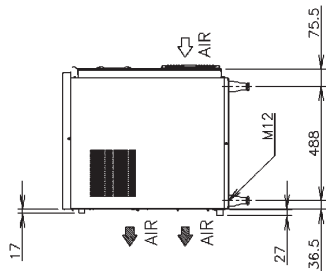
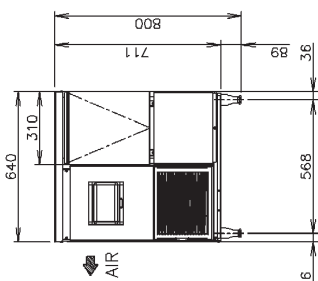
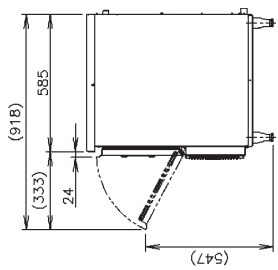
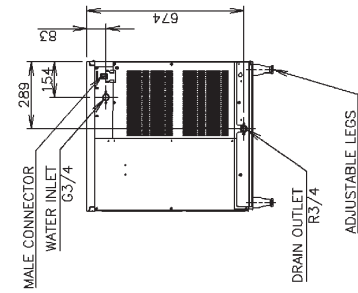
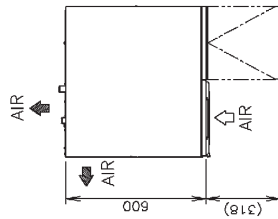

[b] FM-150KE-N

ITEM	HOSHIZAKI NUGGET ICE MAKER
MODEL	FM-150KE-N
POWER SUPPLY	1 Phase 220-240V 50Hz Capacity: 1.46kVA (6.4A)
AMPERAGE	5.1A Starting: 20A
ELECTRIC CONSUMPTION	640W (Power Factor: 58%)
ICE PRODUCTION PER 24H	Approx. 140kg (Ambient Temp. 10C, Water Temp. 10C) Approx. 120kg (Ambient Temp. 21C, Water Temp. 15C) Approx. 100kg (Ambient Temp. 32C, Water Temp. 21C)
SHAPE OF ICE	Nugget
MAX. STORAGE CAPACITY	Approx. 32kg - Levelled (Bin Control Setting, Approx. 27kg)
WATER CONSUMPTION PER 24H	Approx. 0.140m ³ (Ambient Temp. 10C, Water Temp. 10C) Approx. 0.120m ³ (Ambient Temp. 21C, Water Temp. 15C) Approx. 0.100m ³ (Ambient Temp. 32C, Water Temp. 21C)
OUTSIDE DIMENSIONS	640mm(W) x 600mm(D) x 800(798~833)mm(H)
INSULATION FOAM BLOWING AGENT	HFC-245fa, 365mfc
HEAT REJECTION	1120W(Ambient temp.32C, Water temp.21C)
CABINET	Stainless Steel, Galvanized Steel (Rear)
ICE MAKING SYSTEM	Thin ice forming inside Cylinder (Flake Ice)
WATER SUPPLY SYSTEM	Direct Connection to Water Main, Inlet: G3/4 (Rear)
DRAIN SYSTEM	Outlet: R3/4 (Rear)
COMPRESSOR	Hermetic
CONDENSER	Fin and Tube type, Air-cooled
EVAPORATOR	Tube coiled around Cylinder (Solder Plated)
REFRIGERANT	R134a
BIN CONTROL	Actuator and Reed Switch (Time delay controlled)
ICEMAKING WATER CONTROL	Float Switch and Solenoid Valve
ELECTRICAL CIRCUIT PROTECTION	TOA Circuit Breaker
REFRIGERANT CIRCUIT PROTECTION	Compressor Internal Thermostat Condensing Temperature detected by Thermistor(Auto-reset)
MECHANISM PROTECTION	Micro switch (Manual-reset)
INTERLOCK	Shutdown by Microprocessor (Manual-reset)
WEIGHT	Net: 71kg (Gross 82kg)
PACKAGE	Carton 750(W) x 700(D) x 890mm(H)
ACCESSORIES	Scoop, Installation Kit
OPERATING CONDITIONS	Ambient Temp.: 5 - 40C, Water Supply Temp.: 5-35C Water Supply Pressure: 0.05-0.8MPa, Voltage Range: Rated Voltage±10%

*We reserve the right to make changes in specifications and design without prior notice.

1. Install the ice maker properly in accordance with the instructions on location, water supply/drain connections and electrical connections stated in the instruction and installation manuals provided.
2. The ice production depends on the ambient and water temperatures. Refer to the instruction manual.
3. Product Code: F080-C106

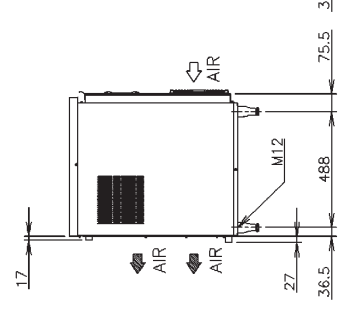
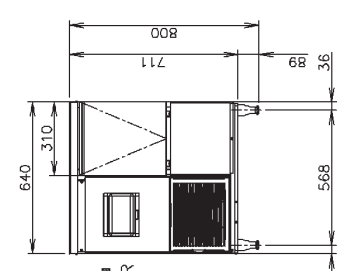
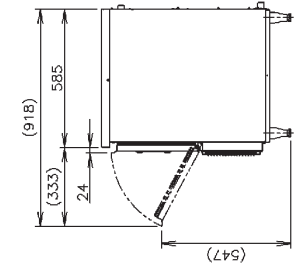
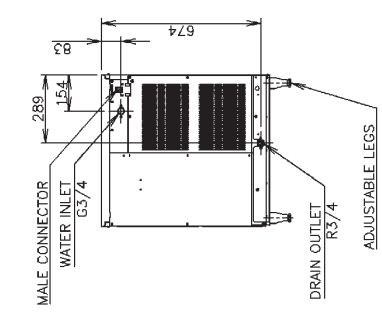
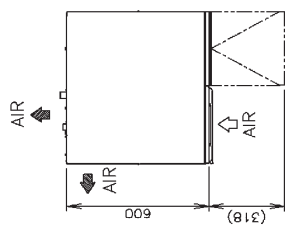

[c] CM-140KE

ITEM	HOSHIZAKI CUBELET ICE MAKER
MODEL	CM-140KE
POWER SUPPLY	1 Phase 220-240V 50Hz Capacity: 1.46kVA (6.4A)
AMPERAGE	5.1A Starting: 20A
ELECTRIC CONSUMPTION	640W (Power Factor: 58%)
ICE PRODUCTION PER 24H	Approx. 140kg (Ambient Temp. 10°C, Water Temp. 10°C) Approx. 115kg (Ambient Temp. 21°C, Water Temp. 15°C) Approx. 95kg (Ambient Temp. 32°C, Water Temp. 21°C)
SHAPE OF ICE	Flake
MAX. STORAGE CAPACITY	Approx. 32kg - Levelled (Bin Control Setting Approx. 27kg)
WATER CONSUMPTION PER 24H	Approx. 0.140m ³ (Ambient Temp. 10°C, Water Temp. 10°C) Approx. 0.115m ³ (Ambient Temp. 21°C, Water Temp. 15°C) Approx. 0.095m ³ (Ambient Temp. 32°C, Water Temp. 21°C)
OUTSIDE DIMENSIONS	640mm(W)×800mm(D)×800(798~833)mm(H)
INSULATION FOAM BLOWING AGENT	HFC-245fa, 365mfc
HEAT REJECTION	1120W/Ambient temp.32°C, Water temp.21°C
CABINET	Stainless Steel, Galvanized Steel (Rear)
ICE MAKING SYSTEM	Thin ice forming inside Cylinder (Flake Ice)
WATER SUPPLY SYSTEM	Direct Connection to Water Main, Inlet: G3/4 (Rear)
DRAIN SYSTEM	Outlet: R3/4 (Rear)
COMPRESSOR	Hermetic
CONDENSER	Fin and Tube type, Air-cooled
EVAPORATOR	Tube coiled around Cylinder (Solder Plated)
REFRIGERANT	R134a
BIN CONTROL	Actuator and Reed Switch (Time delay controlled)
REMAINING WATER CONTROL	Float Switch and Solenoid Valve
ELECTRICAL SAFETY PROTECTION	10A Circuit Breaker
REFRIGERANT CIRCUIT PROTECTION	Compressor Internal Thermostat Condensing Temperature detected by Thermistor(Auto-reset)
MECHANISM PROTECTION	Micro switch (Manual-reset)
INTERLOCK	Shutdown by Microprocessor (Manual-reset)
WEIGHT	Net: 71kg (Gross 82kg)
PACKAGE	Carton 750(W) x 700(D) x 890mm(H)
ACCESSORIES	Scoop, Installation Kit
OPERATING CONDITIONS	Ambient Temp.: 5 - 40°C, Water Supply Temp.: 5-35°C Water Supply Pressure: 0.05-0.8MPa, Voltage Range: Rated Voltage±10%

We reserve the right to make changes in specifications and design without prior notice.

1. Install the ice maker properly in accordance with the instructions on location, water supply/airin connections and electrical connections stated in the instruction and installation manuals provided.
2. The ice production depends on the ambient and water temperatures. Refer to the instruction manual.
3. Product Code: F080-C103

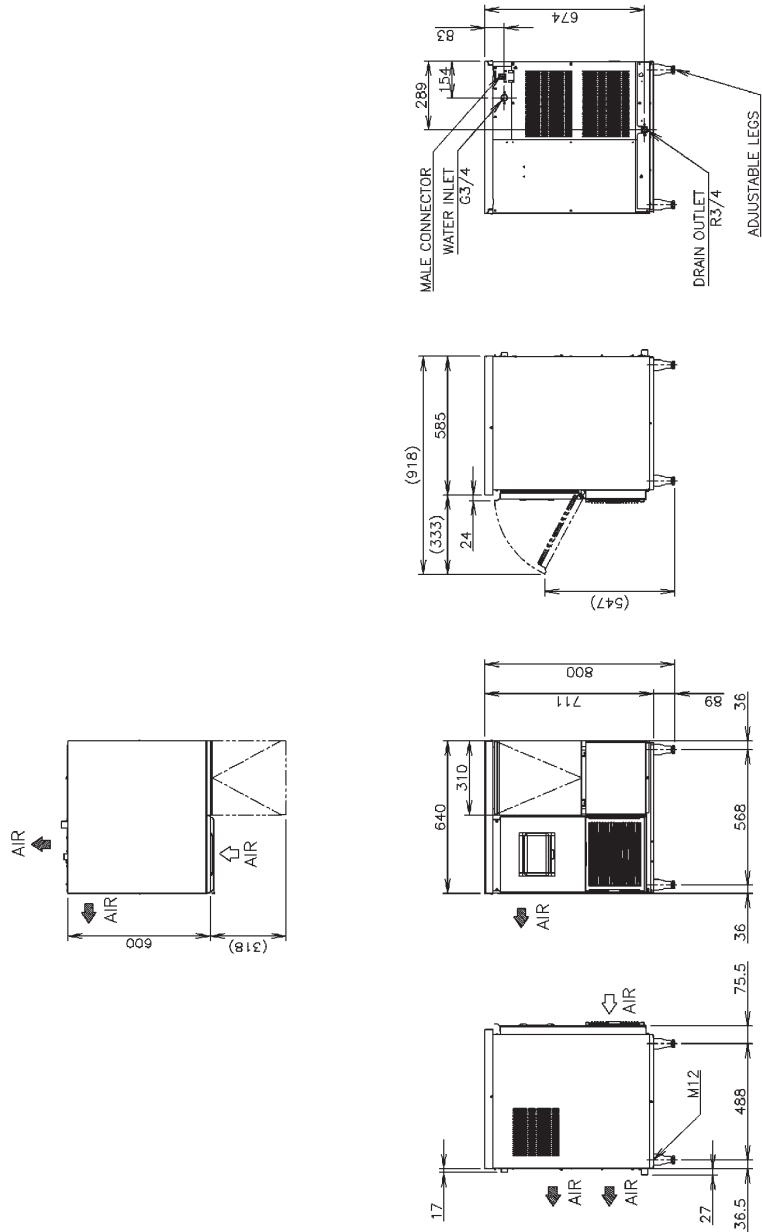

[d] FM-150KE-50

ITEM	HOSHIZAKI FLAKE ICE MAKER
MODEL	FM-150KE-50
POWER SUPPLY	1 Phase 220-240V 50Hz Capacity: 1.46kVA (6.4A)
AMPERAGE	5.1A Starting: 20A
ELECTRIC CONSUMPTION	640W (Power Factor: 58%)
ICE PRODUCTION PER 24H	Approx.150kg (Ambient Temp. 10℃, Water Temp. 10℃) Approx.130kg (Ambient Temp. 21℃, Water Temp. 15℃) Approx.110kg (Ambient Temp. 32℃, Water Temp. 21℃)
SHAPE OF ICE	Flake
MAX. STORAGE CAPACITY	Approx. 57kg - Leveled (Bin Control Setting Approx. 41kg)
WATER CONSUMPTION PER 24H	Approx.0.150m ³ (Ambient Temp. 10℃, Water Temp. 10℃) Approx.0.130m ³ (Ambient Temp. 21℃, Water Temp. 15℃) Approx.0.110m ³ (Ambient Temp. 32℃, Water Temp. 21℃)
OUTSIDE DIMENSIONS	940mm(W)×800mm(D)×800(798×833)mm(H)
INSULATION FOAM BLOWING AGENT	HFC-245fa, 365mfc
HEAT REJECTION	1120W(Ambient temp.32℃, Water temp.21℃)
CABINET	Stainless Steel, Galvanized Steel (Rear)
ICE MAKING SYSTEM	Thin ice forming inside Cylinder (Flake Ice)
WATER SUPPLY SYSTEM	Direct Connection to Water Main, Inlet: G3/4 (Rear)
DRAIN SYSTEM	Outlet: R3/4 (Rear)
COMPRESSOR	Hermetic
CONDENSER	Fin and Tube type, Air-cooled
EVAPORATOR	Tube coiled around Cylinder (Solder Plated)
REFRIGERANT	R134a
BIN CONTROL	Actuator and Reed Switch (Time delay controlled)
REAR PANEL WATER CONTROL	Float Switch and Solenoid Valve
ELECTRICAL CONTROL	10A Circuit Breaker
REFRIGERANT CIRCUIT PROTECTION	Compressor Internal Thermostat Condensing Temperature detected by Thermostat(Auto-reset)
MECHANISM PROTECTION	Micro switch (Manual-reset)
INTERLOCK	Shutdown by Microprocessor (Manual-reset)
WEIGHT	Net: 81kg (Gross 94kg)
PACKAGE	Carton 1050(W) x 700(D) x 890mm(H)
ACCESSORIES	Scoop, Installation Kit
OPERATING CONDITIONS	Ambient Temp.: 5 - 40℃, Water Supply Temp.: 5-35℃ Water Supply Pressure: 0.05-0.8MPa (Voltage Range: Rated Voltage±10%

*We reserve the right to make changes in specifications and design without prior notice.

1. Install the ice maker properly in accordance with the instructions on location, water supply/drain connections and electrical connections stated in the instruction and installation manuals provided.
2. The ice production depends on the ambient and water temperatures. Refer to the instruction manual.
3. Product Code: F080-C127

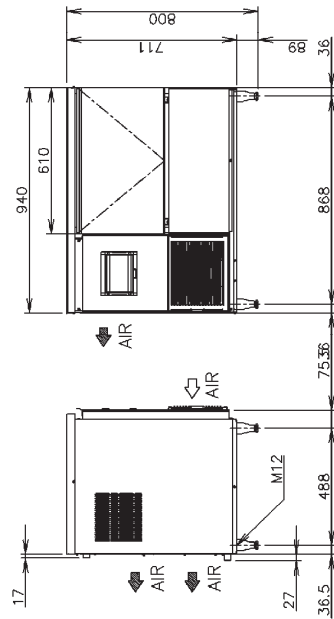
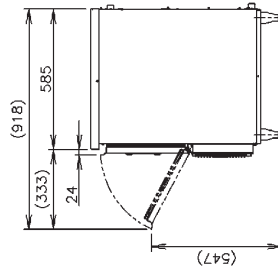
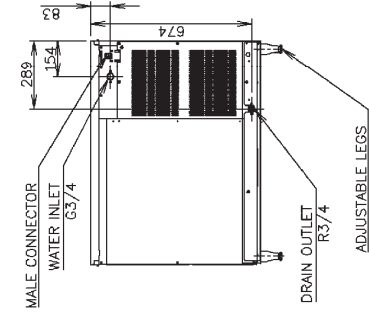
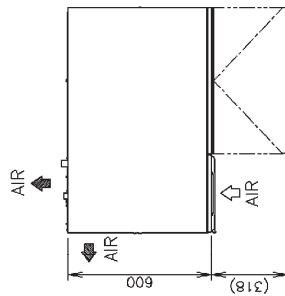

[e] FM-150KE-50-N

ITEM	HOSHIZAKI NUGGET ICE MAKER
MODEL	FM-150KE-50-N
POWER SUPPLY	1 Phase 220-240V 50Hz Capacity: 1.46kVA (6.4A)
AMPERAGE	5.1A Starting: 20A
ELECTRIC CONSUMPTION	640W (Power Factor: 58%)
ICE PRODUCTION PER 24H	Approx. 140kg (Ambient Temp. 10°C, Water Temp. 10°C) Approx. 120kg (Ambient Temp. 21°C, Water Temp. 15°C) Approx. 100kg (Ambient Temp. 32°C, Water Temp. 21°C)
SHAPE OF ICE	Nugget
MAX. STORAGE CAPACITY	Approx. 65kg - Levelled (Bin Control Setting Approx. 47kg)
WATER CONSUMPTION PER 24H	Approx. 0.140m ³ (Ambient Temp. 10°C, Water Temp. 10°C) Approx. 0.120m ³ (Ambient Temp. 21°C, Water Temp. 15°C) Approx. 0.100m ³ (Ambient Temp. 32°C, Water Temp. 21°C)
OUTSIDE DIMENSIONS	940mm(W) x 600mm(D) x 800(798~833)mm(H)
INSULATION FOAM BLOWING AGENT	HFC-245fa, 365mfc
HEAT REJECTION	1120W(Ambient temp. 32°C, Water temp. 21°C)
CABINET	Stainless Steel, Galvanized Steel (Rear)
ICE MAKING SYSTEM	Thin ice forming inside Cylinder (Flake Ice)
WATER SUPPLY SYSTEM	Direct Connection to Water Main, Inlet: G3/4 (Rear)
DRAIN SYSTEM	Outlet: R3/4 (Rear)
COMPRESSOR	Hermetic
CONDENSER	Fin and Tube type, Air-cooled
EVAPORATOR	Tube coiled around Cylinder (Solder Plated)
REFRIGERANT	R134a
BIN CONTROL	Actuator and Reed Switch (Time delay controlled)
TECHNICAL WATER CONTROL	Float Switch and Solenoid Valve
ELECTRICAL SAFETY PROTECTION	10A Circuit Breaker
REFRIGERANT CIRCUIT PROTECTION	Compressor Internal Thermostat Condensing Temperature detected by Thermostat(Auto-reset)
MECHANISM PROTECTION	Micro switch (Manual-reset)
INTERLOCK	Shutdown by Microprocessor (Manual-reset)
WEIGHT	Net: 81kg (Gross 94kg)
PACKAGE	Carton 1050(W) x 700(D) x 890mm(H)
ACCESSORIES	Scoop, Installation Kit
OPERATING CONDITIONS	Ambient Temp.: 5 - 40°C, Water Supply Temp.: 5-35°C Water Supply Pressure: 0.05-0.8MPa, Voltage Range: Rated Voltage±10%

We reserve the right to make changes in specifications and design without prior notice.

1. Install the ice maker properly in accordance with the instructions on location, water supply/drain connections and electrical connections stated in the instruction and installation manuals provided.
2. The ice production depends on the ambient and water temperatures. Refer to the instruction manual.
3. Product Code: F080-C129

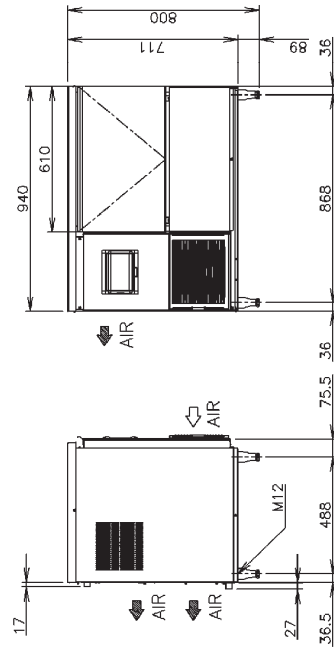
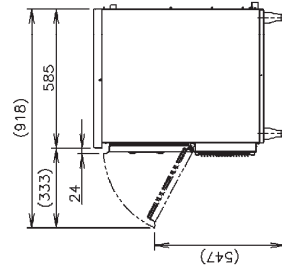
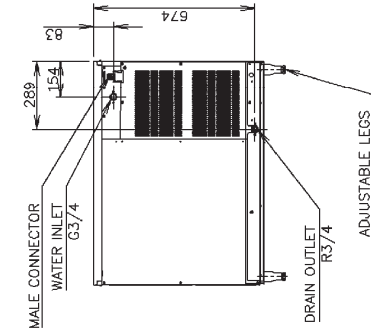
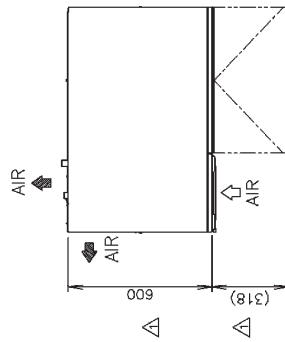

[f] FM-120KE

ITEM	HOSHIZAKI FLAKE ICE MAKER
MODEL	FM-120KE
POWER SUPPLY	1 Phase 220-230V 60Hz Capacity: 1.21kVA (5.3A)
AMPERAGE	3.5A Starting: 19A
ELECTRIC CONSUMPTION	550W (Power Factor: 73%)
ICE PRODUCTION PER 24H	Approx. 145kg (Ambient Temp. 10°C, Water Temp. 10°C) Approx. 120kg (Ambient Temp. 21°C, Water Temp. 15°C) Approx. 100kg (Ambient Temp. 32°C, Water Temp. 21°C)
SHAPE OF ICE	Flake
MAX. STORAGE CAPACITY	Approx. 26kg - Leveled (Bin Control Setting Approx. 21kg)
WATER CONSUMPTION PER 24H	Approx. 0.145m ³ (Ambient Temp. 10°C, Water Temp. 10°C) Approx. 0.125m ³ (Ambient Temp. 21°C, Water Temp. 15°C) Approx. 0.100m ³ (Ambient Temp. 32°C, Water Temp. 21°C)
OUTSIDE DIMENSIONS	640mm(W) x 800mm(D) x 800(798~833)mm(H)
INSULATION FOAM BLOWING AGENT	HFC-245fa, 365mfc
HEAT REJECTION	910W(Ambient temp.32°C, Water temp.21°C)
CABINET	Stainless Steel, Galvanized Steel (Rear)
ICE MAKING SYSTEM	Thin ice forming inside Cylinder (Flake Ice)
WATER SUPPLY SYSTEM	Direct Connection to Water Main, Inlet: G3/4 (Rear)
DRAIN SYSTEM	Outlet: R3/4 (Rear)
COMPRESSOR	Hermetic
CONDENSER	Fin and Tube type, Air-cooled
EVAPORATOR	Tube coiled around Cylinder (Solder Plated)
REFRIGERANT	R134a
BIN CONTROL	Actuator and Reed Switch (Time delay controlled)
KEEPING WATER CONTROL	Float Switch and Solenoid Valve
ELECTRICAL PROTECTION	10A Circuit Breaker
REFRIGERANT CIRCUIT PROTECTION	Compressor Internal Thermostat Condensing Temperature detected by Thermistor(Auto-reset)
MECHANISM PROTECTION	Micro switch (Manual-reset)
INTERLOCK	Shutdown by Microprocessor (Manual-reset)
WEIGHT	Net: 71kg (Gross 82kg)
PACKAGE	Carton 750(W) x 700(D) x 890mm(H)
ACCESSORIES	Scoop, Installation Kit
OPERATING CONDITIONS	Ambient Temp.: 5 - 40°C, Water Supply Temp.: 5-35°C Water Supply Pressure: 0.05-0.8MPa, Voltage Range: Rated Voltage±10%

- *We reserve the right to make changes in specifications and design without prior notice.
1. Install the ice maker properly in accordance with the instructions on location, water supply/drain connections and electrical connections stated in the instruction and installation manuals provided.
 2. The ice production depends on the ambient and water temperatures. Refer to the instruction manual.
 3. Product Code: F080-C161

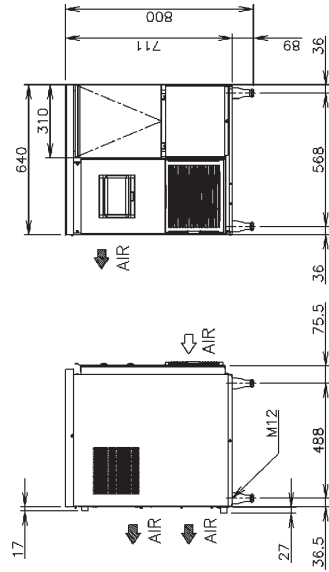
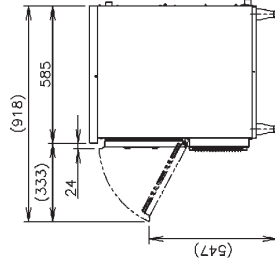
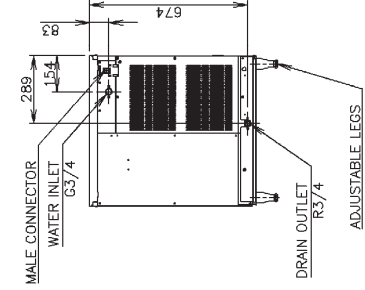
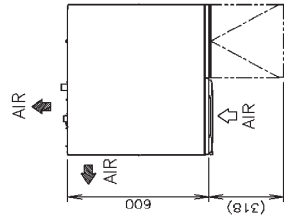

[g] CM-110KE-50

ITEM	HOSHIZAKI CUBELET ICE MAKER
MODEL	CM-110KE-50
POWER SUPPLY	1 Phase 220-230W 60Hz Capacity: 1.21kVA (5.3A)
AMPERAGE	3.5A Starting: 19A
ELECTRIC CONSUMPTION	550W (Power Factor: 7.3%)
ICE PRODUCTION PER 24h	Approx.120kg (Ambient Temp. 10c, Water Temp. 10c) Approx.105kg (Ambient Temp. 21c, Water Temp. 15c) Approx.90kg (Ambient Temp. 32c, Water Temp. 21c)
SHAPE OF ICE	Cubelet
MAX STORAGE CAPACITY	Approx. 65kg - Leveled (Bin Control Setting Approx. 47kg) Approx.0.120m ³ (Ambient Temp. 10c, Water Temp. 10c) Approx.0.105m ³ (Ambient Temp. 21c, Water Temp. 15c) Approx.0.090m ³ (Ambient Temp. 32c, Water Temp. 21c)
WATER CONSUMPTION PER 24h	940mm(W) x 600mm(D) x 800(798~833)mm(H)
OUTSIDE DIMENSIONS	HFC-245fa, 365mfc
INSULATION FOAM BLOWING AGENT	910W(Ambient temp.32c, Water temp.21c)
HEAT REJECTION	Stainless Steel, Galvanized Steel (Rear)
CABINET	Thin ice forming inside Cylinder (Flake Ice)
ICE MAKING SYSTEM	Direct Connection to Water Main, Inlet: G3/4 (Rear)
WATER SUPPLY SYSTEM	Outlet: R3/4 (Rear)
DRAIN SYSTEM	Hermetic
COMPRESSOR	Fin and Tube type, Air-cooled
CONDENSER	Tube coiled around Cylinder (Solder Plated)
EVAPORATOR	R134a
REFRIGERANT	Actuator and Reed Switch (Time delay controlled)
BIN CONTROL	Float Switch and Solenoid Valve
REMAINING WATER CONTROL	10A Circuit Breaker
ELECTRICAL CIRCUIT PROTECTION	Compressor Internal Thermostat Condensing Temperature detected by Thermistor(Auto-reset)
REFRIGERANT CIRCUIT PROTECTION	Micro switch (Manual-reset)
MECHANISM PROTECTION	Shutdown by Microprocessor (Manual-reset)
INTERLOCK	Net: 81kg (Gross 94kg)
WEIGHT	Carton 1050(W) x 700(D) x 890mm(H)
PACKAGE	Scoop, Installation Kit
ACCESSORIES	Ambient Temp.: 5 - 40c, Water Supply Temp.: 5-35c Water Supply Pressure: 0.05-0.8MPa, Voltage Range: Rated Voltage±10%
OPERATING CONDITIONS	

- *We reserve the right to make changes in specifications and design without prior notice.
1. Install the ice maker properly in accordance with the instructions on location, water supply/drain connections and electrical connections stated in the instruction and installation manuals provided.
 2. The ice production depends on the ambient and water temperatures. Refer to the instruction manual.
 3. Product Code: F080-C162

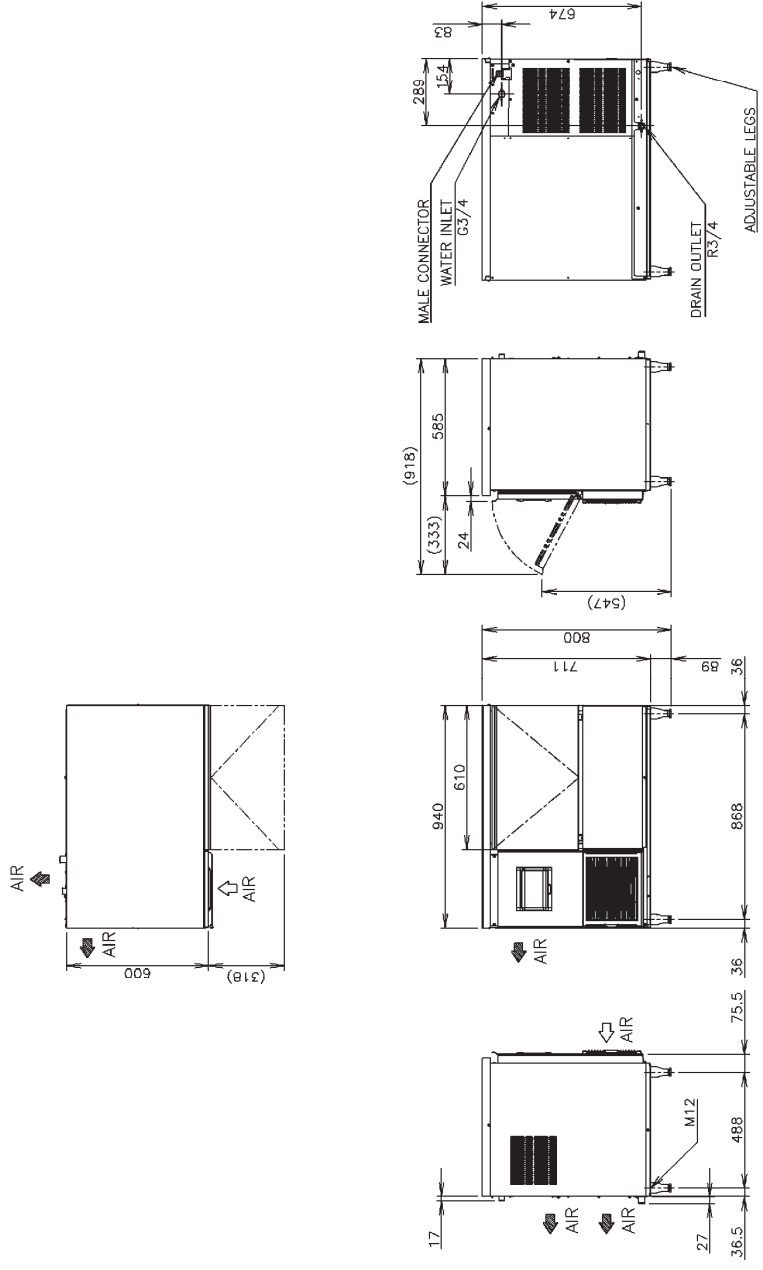

[h] FM-80KE

ITEM	HOSHIZAKI FLAKE ICE MAKER
MODEL	FM-80KE
POWER SUPPLY	1 Phase 220-240V 50Hz Capacity: 0.52kVA (2.0A)
AMPERAGE	1.8A Starting: 5.4A
ELECTRIC CONSUMPTION	300W (Power Factor: 67%)
ICE PRODUCTION PER 24H	Approx. 85kg (Ambient Temp. 10°C, Water Temp. 10°C) Approx. 75kg (Ambient Temp. 21°C, Water Temp. 15°C) Approx. 60kg (Ambient Temp. 32°C, Water Temp. 21°C)
SHAPE OF ICE	Flake
MAX. STORAGE CAPACITY	Approx. 26kg - Leveled (Bin Control Setting Approx. 21kg)
WATER CONSUMPTION PER 24H	Approx. 6.085m ³ (Ambient Temp. 10°C, Water Temp. 10°C) Approx. 6.075m ³ (Ambient Temp. 21°C, Water Temp. 15°C) Approx. 6.060m ³ (Ambient Temp. 32°C, Water Temp. 21°C)
OUTSIDE DIMENSIONS	640mm(W) x 800mm(D) x 800(798~833)mm(H)
INSULATION FOAM BLOWING AGENT	HFC-245fa, 365mfc
HEAT REJECTION	470W (Ambient temp. 32°C, Water temp. 21°C)
CABINET	Stainless Steel, Galvanized Steel (Flake Ice)
ICE MAKING SYSTEM	Thin ice forming inside Cylinder (Flake Ice)
WATER SUPPLY SYSTEM	Direct Connection to Water Main, Inlet: G3/4 (Rear)
DRAIN SYSTEM	Outlet: R3/4 (Rear)
COMPRESSOR	Hermetic
CONDENSER	Fin and Tube type, Air-cooled
EVAPORATOR	Tube coiled around Cylinder (Solder Plated)
REFRIGERANT	RT 34a
BIN CONTROL	Actuator and Reed Switch (Time delay controlled)
ICE MAKING WATER CONTROL	Float Switch and Solenoid Valve
ELECTRICAL PROTECTION	6A Circuit Breaker
REFRIGERANT CIRCUIT PROTECTION	Compressor Internal Thermostat Condensing Temperature detected by Thermistor (Auto-reset)
MECHANISM PROTECTION	Micro switch (Manual-reset)
INTERLOCK	Shutdown by Microprocessor (Manual-reset)
WEIGHT	Net: 65kg (Gross 75kg)
PACKAGE	Carton 750(W) x 700(D) x 890mm(H)
ACCESSORIES	Scoop, Installation Kit
OPERATING CONDITIONS	Ambient Temp.: 5 - 40°C, Water Supply Temp.: 5-35°C Water Supply Pressure: 0.05-0.8MPa, Voltage Range: Rated Voltage ± 10%

- *We reserve the right to make changes in specifications and design without prior notice.
1. Install the ice maker properly in accordance with the instructions on location, water supply/drain connections and electrical connections stated in the instruction and installation manuals provided.
 2. The ice production depends on the ambient and water temperatures. Refer to the instruction manual.
 3. Product Code: F079

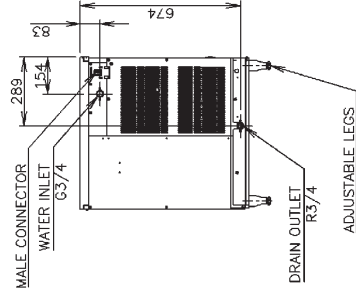
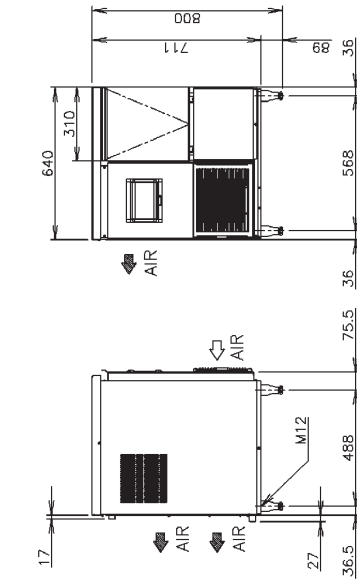
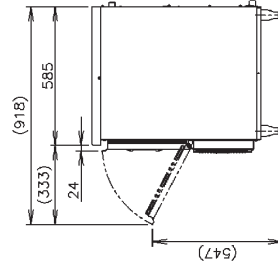
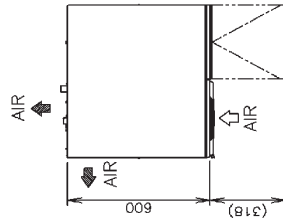

[i] FM-80KE-N

ITEM	HOSHIZAKI NUGGET ICE MAKER
MODEL	FM-80KE-N
POWER SUPPLY	1 Phase 220-240V 50Hz Capacity: 0.52kVA (2.0A)
AMPERAGE	1.8A Starting: 5.4A
ELECTRIC CONSUMPTION	300W (Power Factor: 67%)
ICE PRODUCTION PER 24h	Approx. 65kg (Ambient Temp. 10°C, Water Temp. 10°C) Approx. 55kg (Ambient Temp. 21°C, Water Temp. 15°C) Approx. 45kg (Ambient Temp. 32°C, Water Temp. 21°C)
SHAPE OF ICE	Nugget
MAX. STORAGE CAPACITY	Approx. 32kg - Levelled (Bin Control Setting Approx. 27kg)
WATER CONSUMPTION PER 24h	Approx. 0.065m ³ (Ambient Temp. 10°C, Water Temp. 10°C) Approx. 0.055m ³ (Ambient Temp. 21°C, Water Temp. 15°C) Approx. 0.045m ³ (Ambient Temp. 32°C, Water Temp. 21°C)
OUTSIDE DIMENSIONS	640mm(W) x 800mm(D) x 800(798~833)mm(H)
INSULATION FOAM BLOWING AGENT	HFC-245fa, 365mfc
HEAT REJECTION	470W(Ambient temp.32°C,Water temp.21°C)
CABINET	Stainless Steel, Galvanized Steel (Rear)
ICE MAKING SYSTEM	Thin ice forming, inside Cylinder (Flake Ice)
WATER SUPPLY SYSTEM	Direct Connection to Water Main, Inlet: G3/4 (Rear)
DRAIN SYSTEM	Outlet: R3/4 (Rear)
COMPRESSOR	Hermetic
CONDENSER	Fin and Tube type, Air-cooled
EVAPORATOR	Tube coiled around Cylinder (Solder Plated)
REFRIGERANT	R134a
BIN CONTROL	Actuator and Reed Switch (Time delay controlled)
ICE MAKING WATER CONTROL	Float Switch and Solenoid Valve
ELECTRICAL SAFETY PROTECTION	6A Circuit Breaker
REFRIGERANT CIRCUIT PROTECTION	Compressor Internal Thermostat Condensing Temperature detected by Thermostat(Auto-reset)
MECHANICAL PROTECTION	Micro switch (Manual-reset)
INTERLOCK	Shutdown by Microprocessor (Manual-reset)
WEIGHT	Net: 65kg (Gross 75kg)
PACKAGE	Carton 750(W) x 700(D) x 890mm(H)
ACCESSORIES	Scoop, Installation Kit
OPERATING CONDITIONS	Ambient Temp.: 5 - 40°C, Water Supply Temp.: 5-35°C Water Supply Pressure: 0.05-0.8MPa, Voltage Range: Rated Voltage 10%

- *We reserve the right to make changes in specifications and design without prior notice.
1. Install the ice maker properly in accordance with the instructions on location, water supply/drain connections and electrical connections stated in the instruction and installation manuals provided.
 2. The ice production depends on the ambient and water temperatures. Refer to the instruction manual.
 3. Product Code: F079-C106

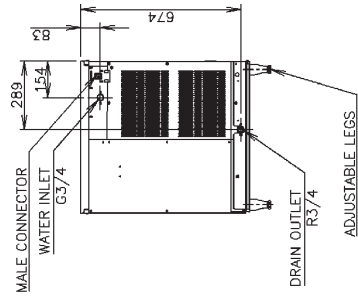
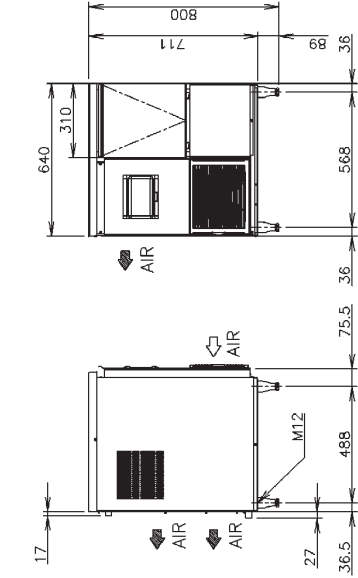
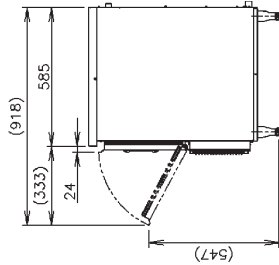
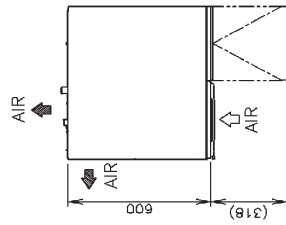

2. CONSTRUCTION

[a] FM-150KE(-N), CM-140KE, FM-150KE-50(-N), FM-120KE, CM-110KE-50

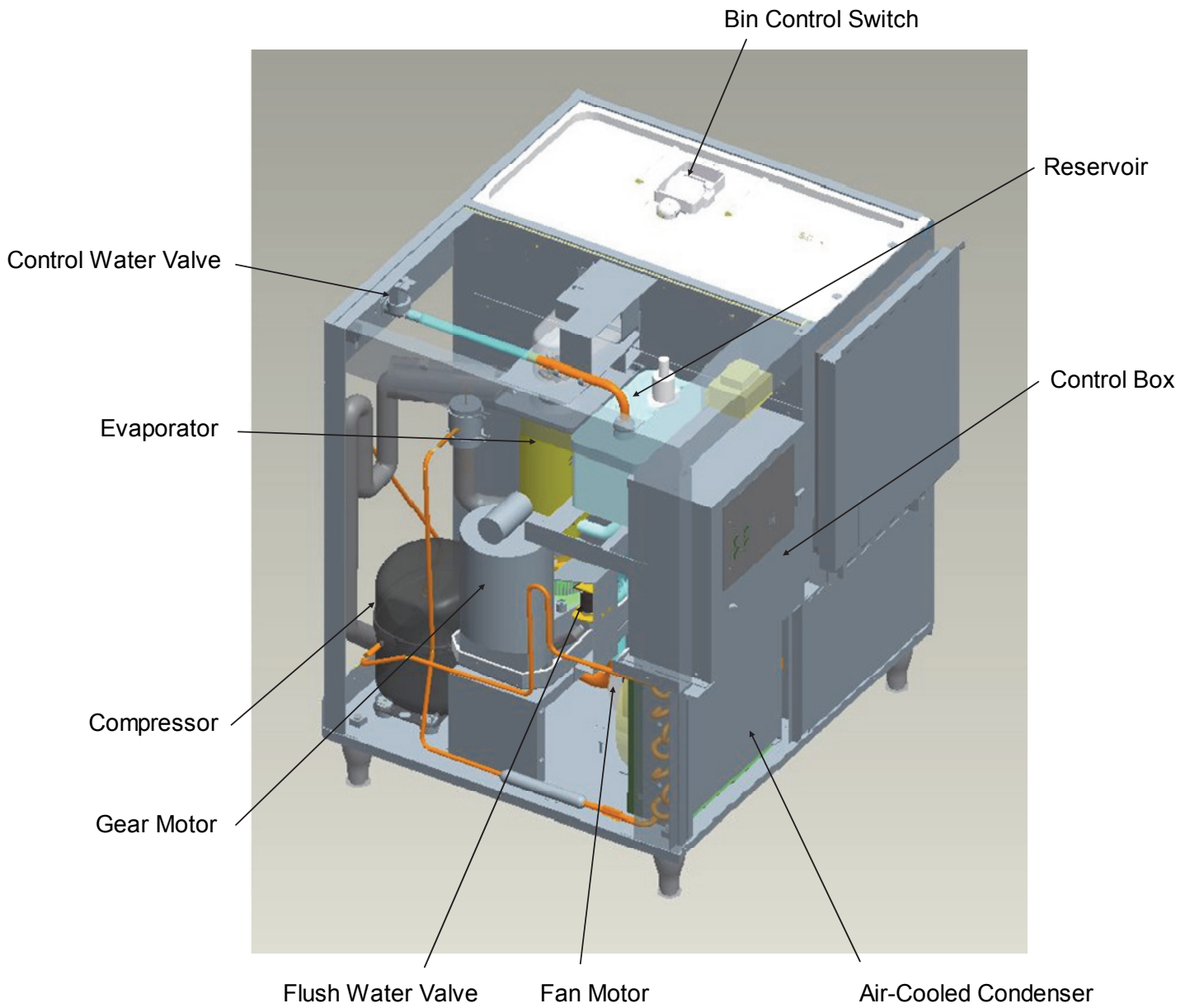

[b] FM-80KE(-N)

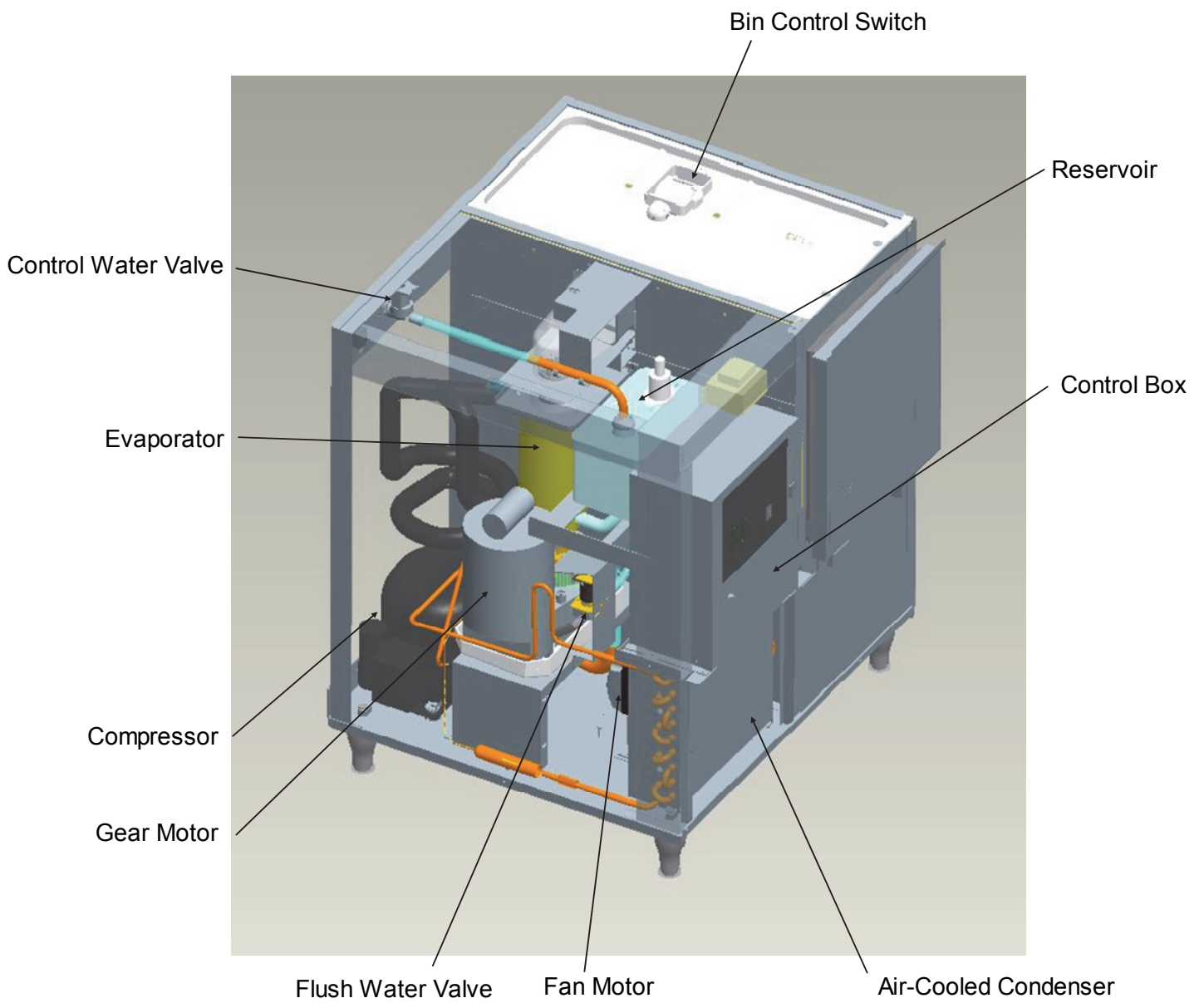

II. MAINTENANCE AND CLEANING INSTRUCTIONS

IMPORTANT

1. This icemaker must be maintained individually, referring to the instruction manual and labels provided with the icemaker.
2. To achieve optimum icemaker performance, the following parts need periodic inspection and maintenance:
 - Extruding head (upper bearing)
 - Housing (lower bearing)
 - Mechanical seal

These parts should be inspected after two years from installation or 10,000 hours of operation, whichever comes first, and once a year thereafter. Their service life, however, depends on water quality and environment. More frequent inspection and maintenance are recommended in bad or severe water conditions.

1. EXTRUDING HEAD (UPPER BEARING), HOUSING (LOWER BEARING)

These parts should be replaced if a diametrical gap of more than 0.5 mm is found when at least three spots are checked by changing the direction of the auger on each bearing.

It depends on the water quality and conditions, but normally the bearings should be checked for wear after a total of 8,000 - 10,000 hour operation from installation date.

Note: The clearance between the auger blades and the evaporator interior is 0.4 - 0.5 mm. If the bearings and rotating parts are worn out to create a larger clearance, the evaporator interior may be damaged. (The diameters differ by 0.8 - 1.0 mm.)

If the auger surfaces against which the bearings contact are no longer smooth or show any burrs or abrasions during the above inspection, replace the auger. The sealing bolt must be tightened equally to torque of $784\text{N}\cdot\text{cm} \pm 10\%$.

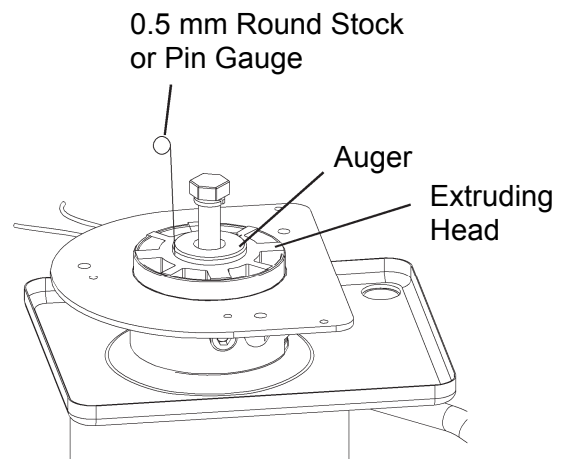

For reference only
(May differ from actual design)

2. MECHANICAL SEAL

The mechanical seal prevents water leaks from between the auger and the housing bearing and gradually wears out to reduce its watertightness. Check the amount of water leakage from the drain pipe located at the side of the gear case to determine the necessity of replacement.

<u>Total operation time</u>	<u>Water leakage</u>
3,000 hours	0.1 mL/h
10,000 hours	0.5 mL/h

Attach the mechanical seal with its floating sheet facing the housing. After replacement, there should be no water leakage from the mating surface.

Note: The water leakage will exceed the above amount with scale/dirt build up or damage on the mating surface. Replace the mechanical seal when the water leakage exceeds 0.5 mL/h.

3. GEAR MOTOR

After the following hours of operation, check the gear motor for excessive noise caused by increased torque or deterioration of mechanical parts.

Bearing, gear and other mechanical parts:	10,000 hours
Oil seal:	5 years

Note: When the output shaft oil seal is exposed to a large amount of water at one time, water may enter the gear case. Always drain the water circuit before removing the auger for service.

4. CONDENSER (AIR-COOLED MODEL ONLY)

Check the condenser once a year, and clean if required by using a brush or vacuum cleaner. More frequent cleaning may be required depending on the location of the icemaker.

5. AIR FILTER (AIR-COOLED MODEL ONLY)

Plastic mesh air filters remove dirt or dust from the air, and keep the condenser from getting clogged. If the filters get clogged, the icemaker's performance will be reduced. Remove and clean the air filters at least twice per month:

- 1) Slide the air filter off the louver.
- 2) Clean the air filter by using a vacuum cleaner. When severely clogged, use warm water and a neutral cleaner to wash the air filter.
- 3) Rinse and dry the air filter thoroughly, and place it in position.

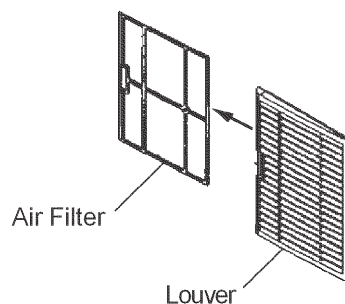

6. CONTROL WATER VALVE

- 1) Disconnect the power source.
- 2) Close the water supply tap.
- 3) Disconnect the inlet hose from the water valve.
- 4) Clean the filter packing using a brush.
- 5) Replace the filter packing and inlet hose in their correct positions.
- 6) Open the water supply tap.
- 7) Connect the power source.
- 8) Check for leaks.

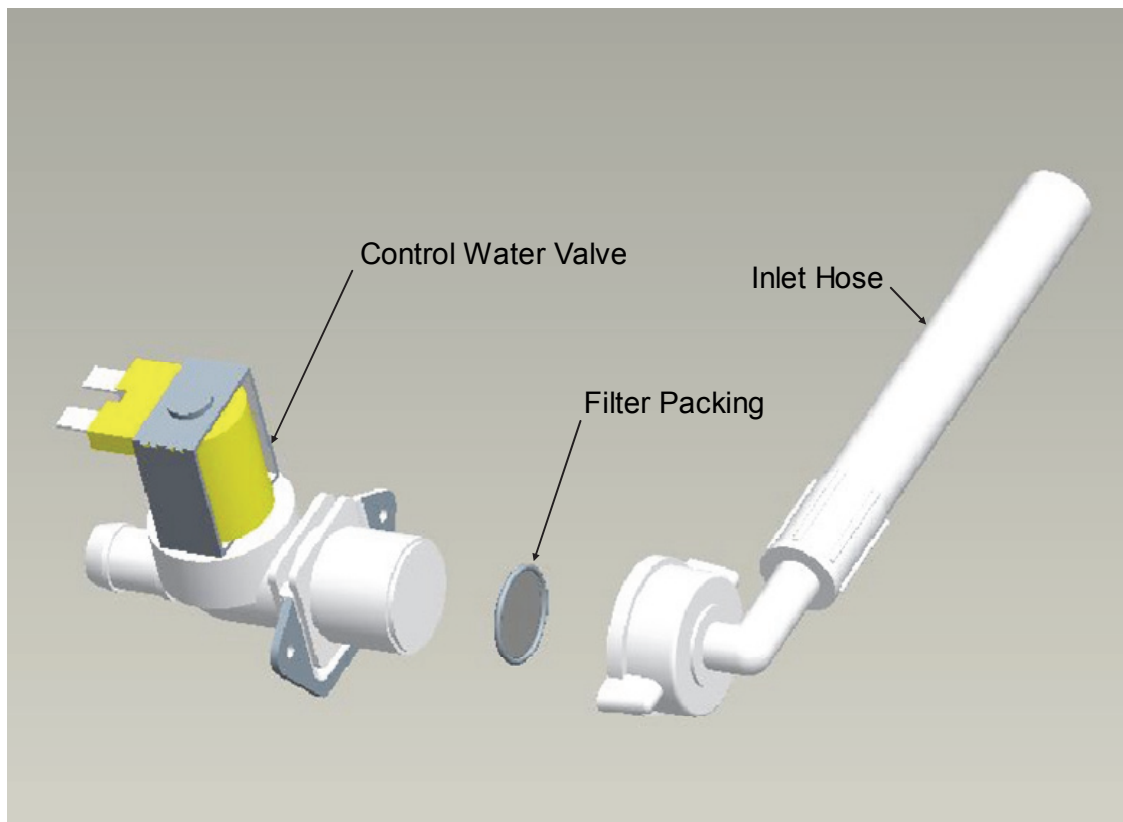

7. CLEANING OF WATER SYSTEM

WARNING

1. HOSHIZAKI recommends cleaning this unit at least twice a year. More frequent cleaning, however, may be required in some existing water conditions.
2. Do not touch the operation switch with damp hands.
3. Always wear rubber gloves, eye protectors, apron, etc. for safe handling of the cleaner and sanitiser.
4. Use the cleaners and sanitisers recommended by Hoshizaki. Contact your local Hoshizaki office for further details. (The instructions below give an example of those recommended cleaners and sanitisers.)
5. Never mix cleaning and sanitising solutions in an attempt to shorten cleaning time.
6. Wipe off any splashed or spilt cleaner/sanitiser immediately.
7. Do not use any ammonia type cleaners on any part of the icemaker.

CAUTION

Do not use ice produced with cleaning and sanitizing solutions. Be sure none remains in the storage bin on completion of cleaning.

<STEP 1>

Dilute the solutions with water as follows:

Cleaning solution: "Nickel-Safe Ice Machine Cleaner" by The Rectorseal Corporation or similar. Prepare approximately 3 L of solution as directed on the container.

Sanitising solution: 30 mL of 5.25% sodium hypochlorite with 7.6 L of water or the Hoshizaki recommended sanitiser as directed on the container.

IMPORTANT

For safety and maximum effectiveness, use the solutions immediately after dilution.

<STEP 2>

Use the cleaning solution to remove lime deposits in the water system.

- 1) Open the plastic access flap on the front panel.
- 2) Press the stop button to activate the flush cycle (approx. 10 minutes).

- 3) Remove all ice from the storage bin to avoid contamination by the cleaner.
- 4) Unplug the icemaker. Remove the top and front panels.
- 5) Remove the cover of the reservoir. Remove any loose debris or scale.
- 6) Carefully fill the reservoir with the solution to the overflow point. If necessary, use a small brush to clean the inside of the reservoir.
- 7) Refit the reservoir cover.
- 8) Check that the operation switch is in the "ON" position.
- 9) Refit the front and top panels.
- 10) Allow the icemaker to stand for about 10 minutes, then plug in the icemaker to make ice with the solution.
- 11) With the water supply tap open, allow the machine to continue icemaking for a further 20 minutes. Open the access flap and press the stop button.
- 12) Allow time for the gear motor to stop and the water system to drain.
- 13) Allow the icemaker to make ice for approximately 10 minutes.
- 14) Pour warm water into the storage bin to melt any ice down the drain.

Note: 1. If the machine has heavy deposits of scale, repeat the complete cleaning procedure.

2. Do not increase the proportion of cleaning solution to shorten cleaning times, as this may lock the auger when completing item 10).

<STEP 3>

Note: Sanitising should always be completed after cleaning or alternately as an individual procedure if conditions exist to make it necessary.

Use 2.8 litres of the sanitising solution to sanitise the icemaker.

- 15) Follow items 1) to 14) to complete sanitisation of the water system.

<STEP 4>

Use the remaining sanitising solution to sanitise removable parts.

- 16) Open the door and remove the actuator assembly from the upper panel by pushing the tabs on the actuator base inward.
- 17) Remove the reed switch and the actuator from the actuator base.
- 18) Remove the thumbscrews, the spout and the spout gasket.

19) Immerse these parts in the sanitizing solution for about 15 minutes.

20) Rinse these parts thoroughly with clean water.

IMPORTANT

If the solution is left on these parts, they will corrode.

21) Refit the removed parts in reverse order.

22) Close the water supply tap.

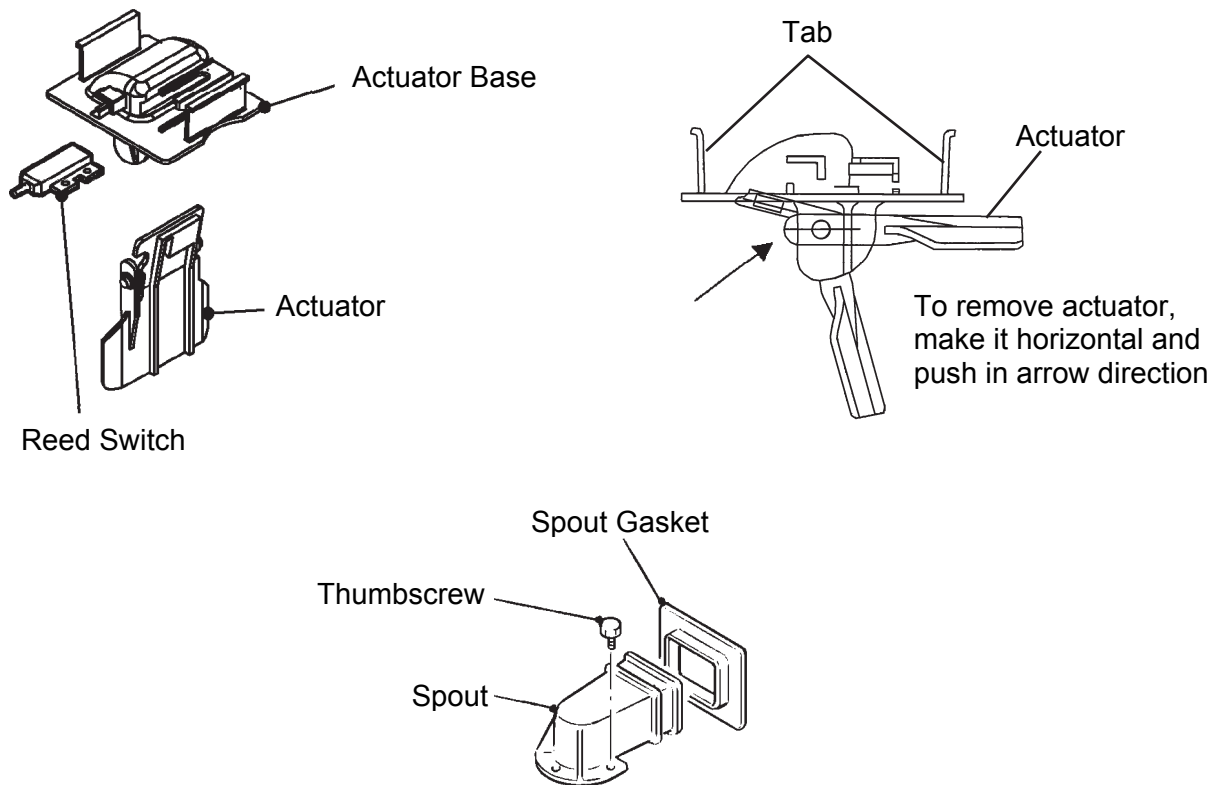

III. TECHNICAL INFORMATION

1. WATER CIRCUIT AND REFRIGERANT CIRCUIT

[a] FM-150KE(-N), CM-140KE, FM-150KE-50(-N), FM-120KE, CM-110KE-50

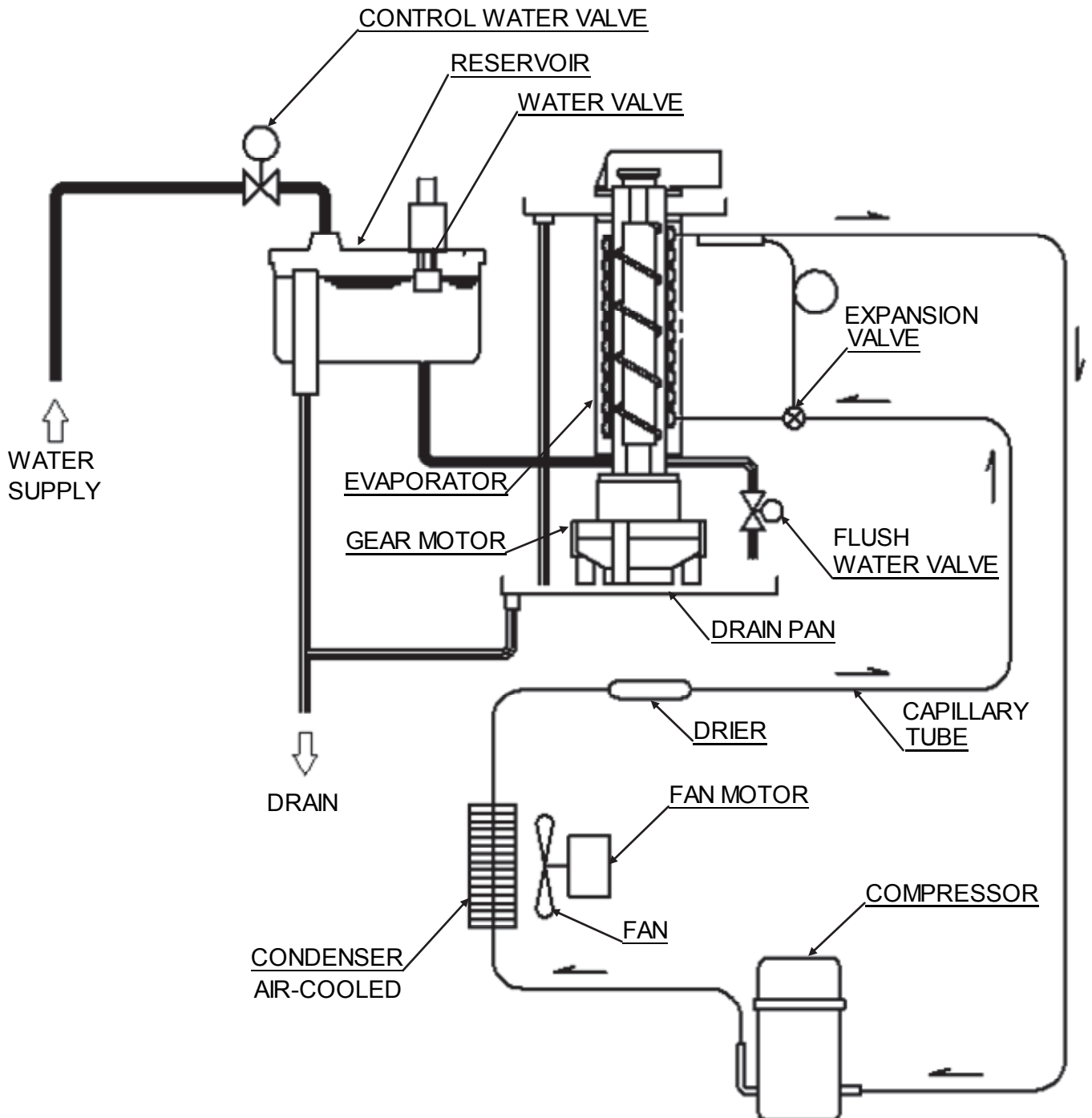

[b] FM-80KE(-N)

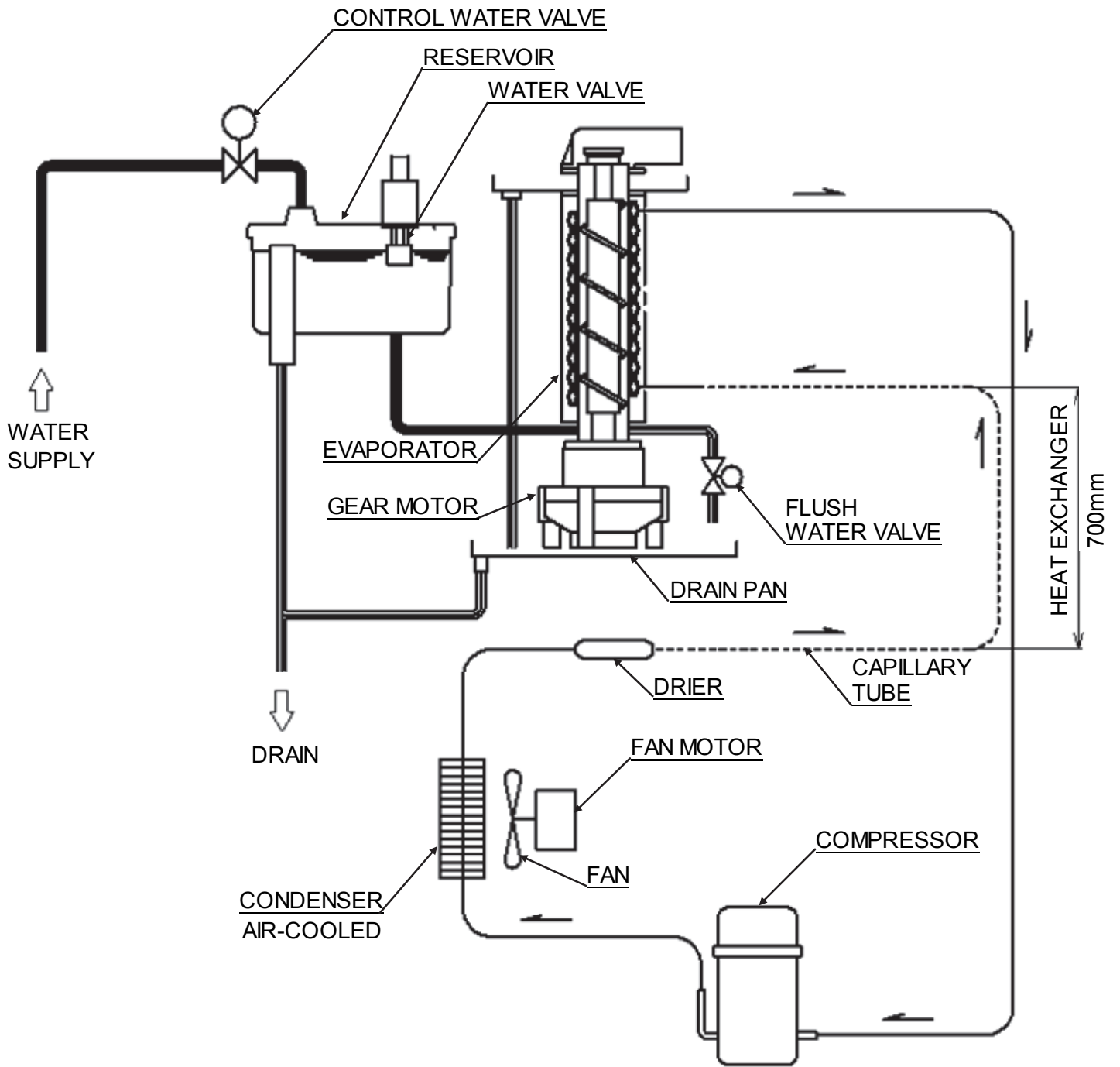

2. WIRING DIAGRAM

[a] WIRING DIAGRAM

FM-150KE(-N), CM-140KE, FM-150KE-50(-N), FM-120KE, CM-110KE-50

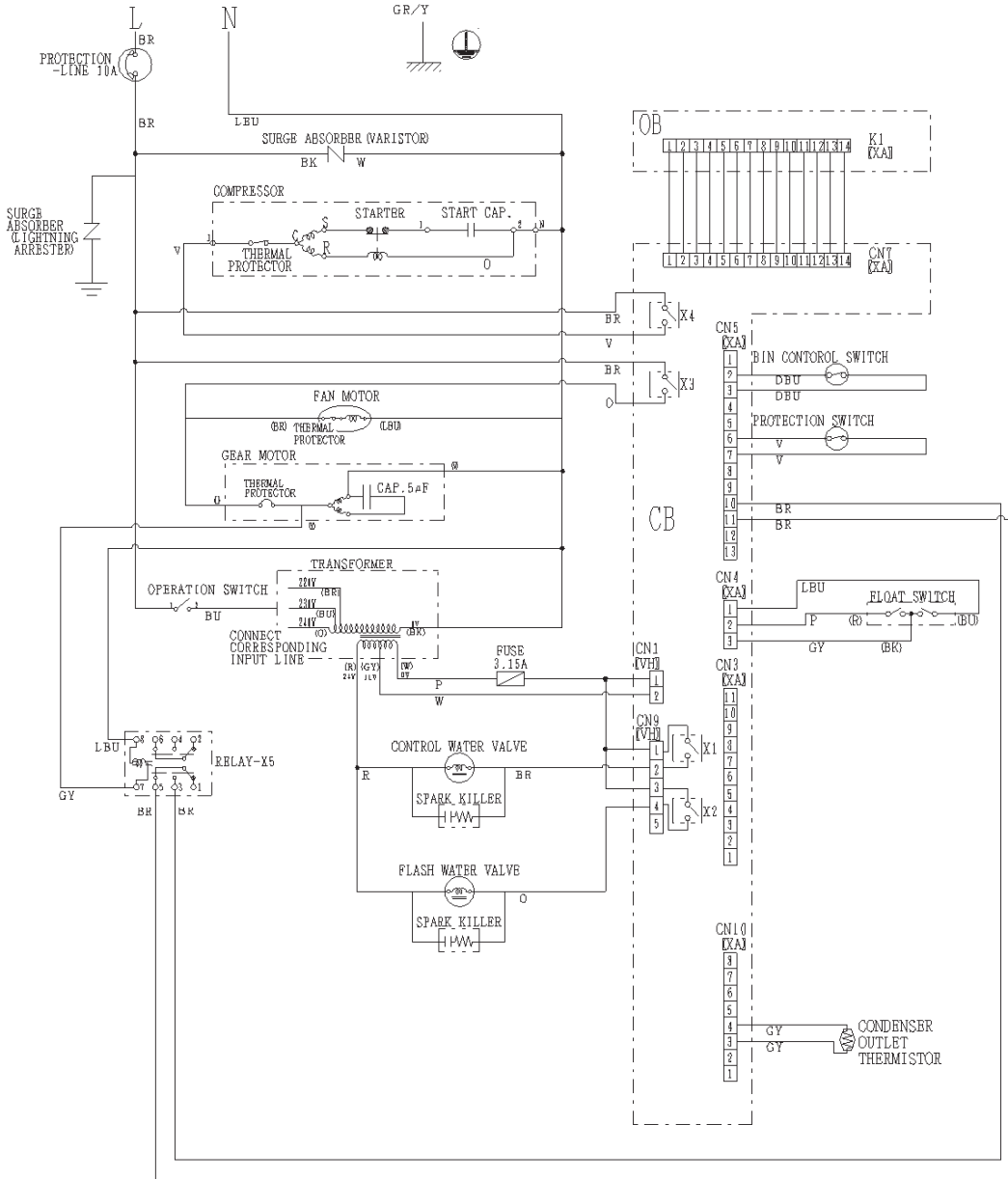

SET No.
16

WIRE COLOR CODE	
O	ORANGE
R	RED
BU	BLUE
DBU	DARK BLUE
BR	BROWN
GY	GRAY
LBU	LIGHT BLUE
P	PINK
Y	YELLOW
V	VIOLET
BK	BLACK
W	WHITE
GR/Y	GREEN/YELLOW

FM-80KE(-N)

SET No.
16

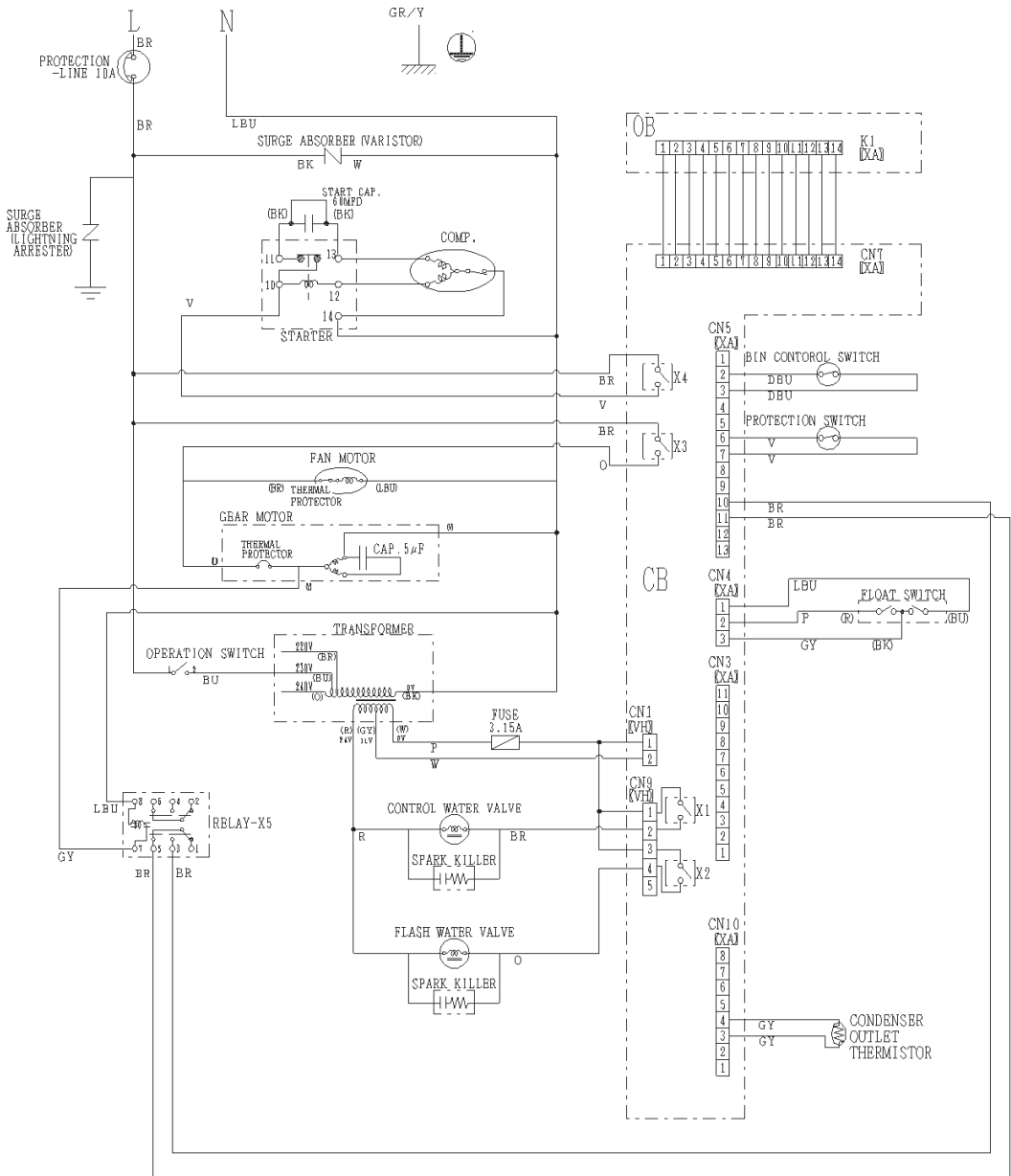

WIRE COLOR CODE	
O	ORANGE
R	RED
BU	BLUE
DBU	DARK BLUE
BR	BROWN
GY	GRAY
LBU	LIGHT BLUE
P	PINK
Y	YELLOW
V	VIOLET
BK	BLACK
W	WHITE
GR/Y	GREEN/YELLOW

[b] CONTROL BOX LAYOUT

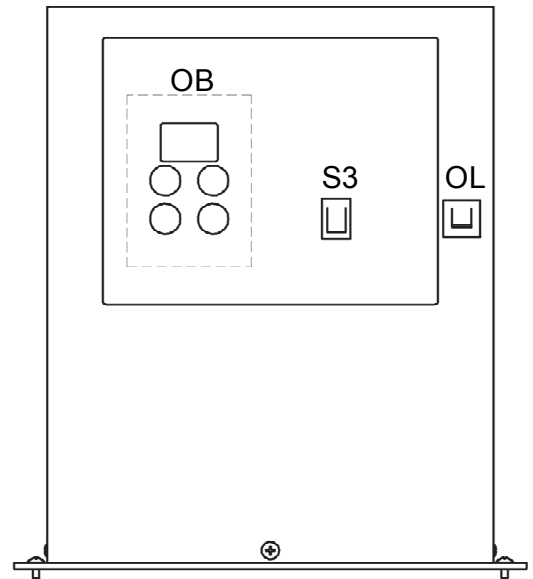
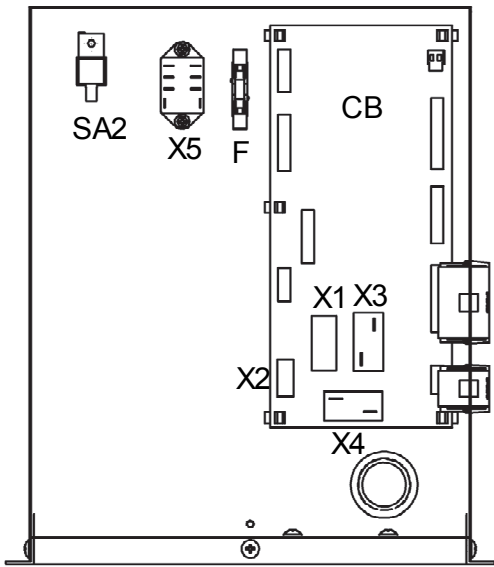

CB	CONTROLLER BOARD - MAIN
OB	CONTROLLER BOARD - OPERATION
X1	POWER RELAY (CONTROL WATER VALVE, ON BOARD)
X2	POWER RELAY (FLUSH WATER VALVE, ON BOARD)
X3	POWER RELAY (GEAR MOTOR, ON BOARD)
X4	POWER RELAY (COMPRESSOR, ON BOARD)
X5	POWER RELAY (GM DRIVE DETECTOR)
S3	OPERATION SWITCH
OL	CIRCUIT PROTECTOR (10A)
SA2	SURGE ABSORBER (LIGHTENING ARRESTER)
F	FUSE 3.15A

3. ICEMAKING MECHANISM

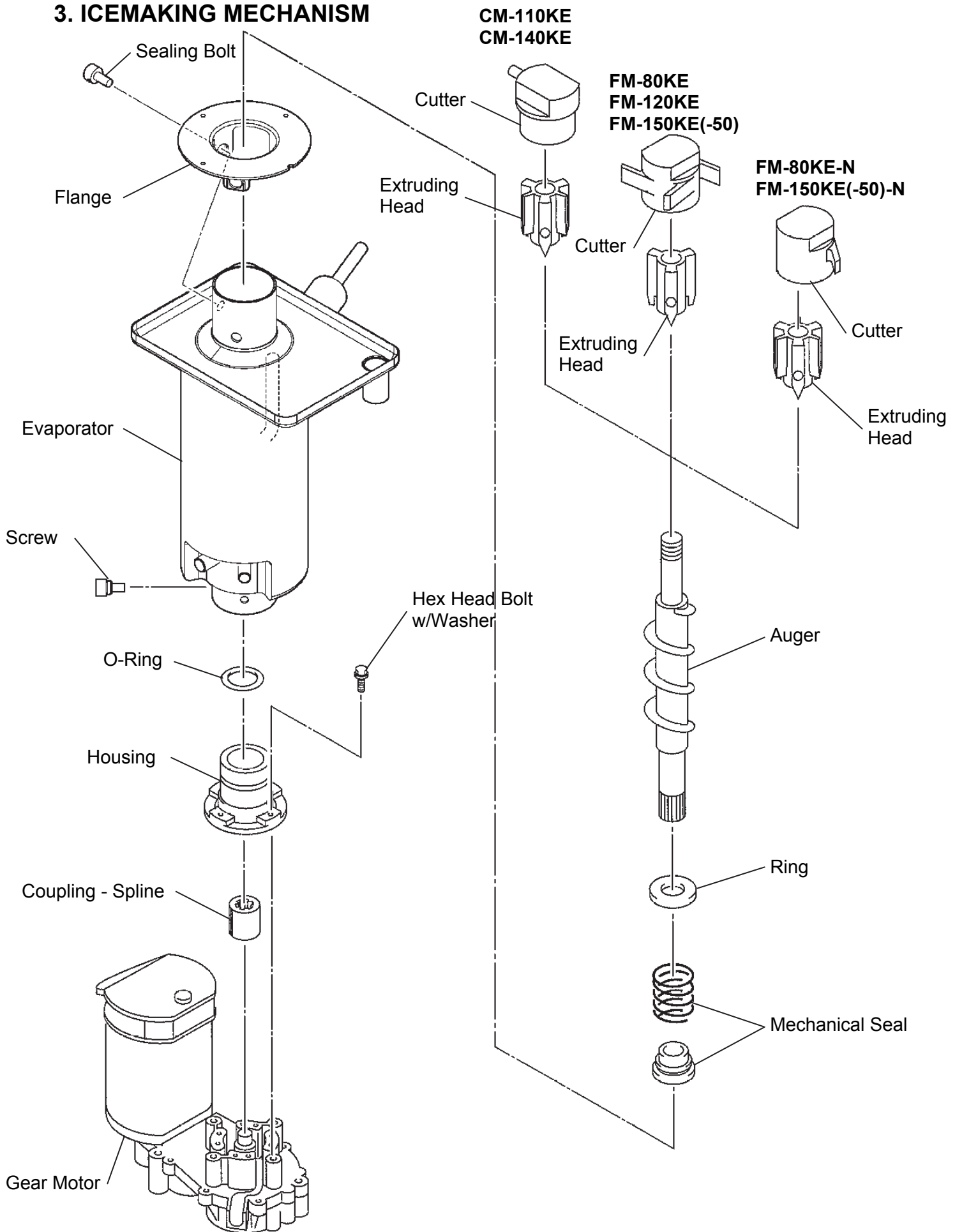

[a] EVAPORATOR (CASING)

The evaporator consists of a stainless steel icemaking cylinder coiled with a refrigeration pipe and wrapped together with a polyurethane foam insulation material. Water coming from the inlet into the evaporator will be frozen into ice. The ice spout is located on top of the evaporator.

[b] AUGER

The stainless steel auger is supported by the upper and lower bearings of the evaporator and slowly rotated by the gear motor, while scraping off the ice forming on the inner wall of the cylinder and pushing up to the ice spout.

[c] EXTRUDING HEAD (BEARING)

The stainless steel extruding head is provided with a press-fit plastic bearing inside and fixed on top of the evaporator. The extruding head functions as the auger bearing and compresses the sherbet ice carried up by the auger into a column shape with the path resistance.

[d] HOUSING

The cast bronze housing is provided with a press-fit plastic bearing inside and fixed on the bottom of the evaporator for connection with the gear motor.

[e] MECHANICAL SEAL

The mechanical seal on the lower auger bearing prevents icemaking water leaks into the evaporator. The mating surfaces are made of ceramic and carbon.

[f] COUPLING (SPLINE JOINT)

The auger bottom and gear motor output shaft are splined and connected with the spline joint.

[g] GEAR MOTOR

The gear motor consists of a 200W 1 phase 240V or 80W 1 phase 220 - 240 / 220V drive motor integrated with a decelerator and provided with a built-in auto-reset thermal protector. When the thermal protector trips, the controller board will stop the gear motor. The thermal protector trips when the gear motor mechanism is overloaded or when excessively high or low voltage is applied on the gear motor. The electrical capacity must be increased if a large current flows through the surrounding equipment.

[h] BELT HEATER (provided on some models)

The belt heater is provided to reduce the load of ice passing the extruding head during a freeze cycle and to prevent vapor lock during a flush cycle.

[i] REMOVABLE FLANGE

The flange used to be welded on the evaporator to fix the spout. But sometimes the extruding head applies excessive load on the evaporator to compress ice, resulting in breaking the welded joints. To avoid the load, the flange has been changed to a separate part to be secured together with the extruding head by using sealing bolts.

[j] SEALING BOLT

Sometimes the icemaking operation may produce white solids on the drip pan. They are deposits of silica and calcium contents in the icemaking water leaking from the sealing bolt. The bolt is provided with retaining and sealing functions, which may be reduced by the load and vibration during a freeze cycle. Do not reuse a removed sealing bolt.

Solids deposited from
sealing bolt



4. ELECTRIC CIRCUIT

CAUTION

Reassemble all the components as they were after servicing the unit according to a service call.

[a] BASIC OPERATION

The icemaker starts water supply when the operation switch is moved to the “ON” position. On completion of water supply, the gear motor starts immediately. After 5 minutes the compressor starts to begin icemaking operation.

In normal operation, the icemaker shuts down when the storage bin fills up to trip the bin control switch or the stop button is pressed. When the compressor operates for 6 hours in total and continuously for more than 10 minutes, the icemaker supplies water until the reservoir fills up and starts a drain cycle. After 10 minutes the icemaker automatically starts water supply and resumes icemaking operation.

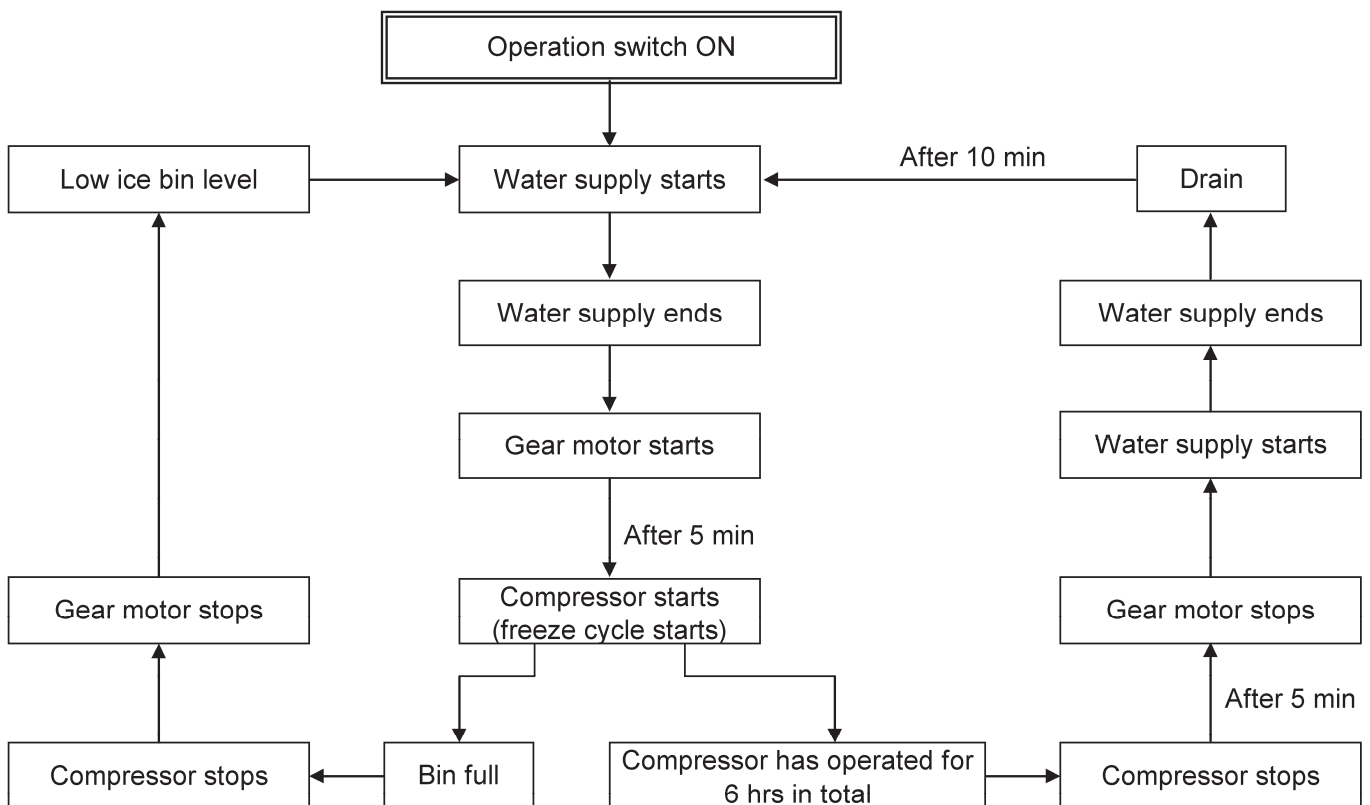

[b] TIMING CHART

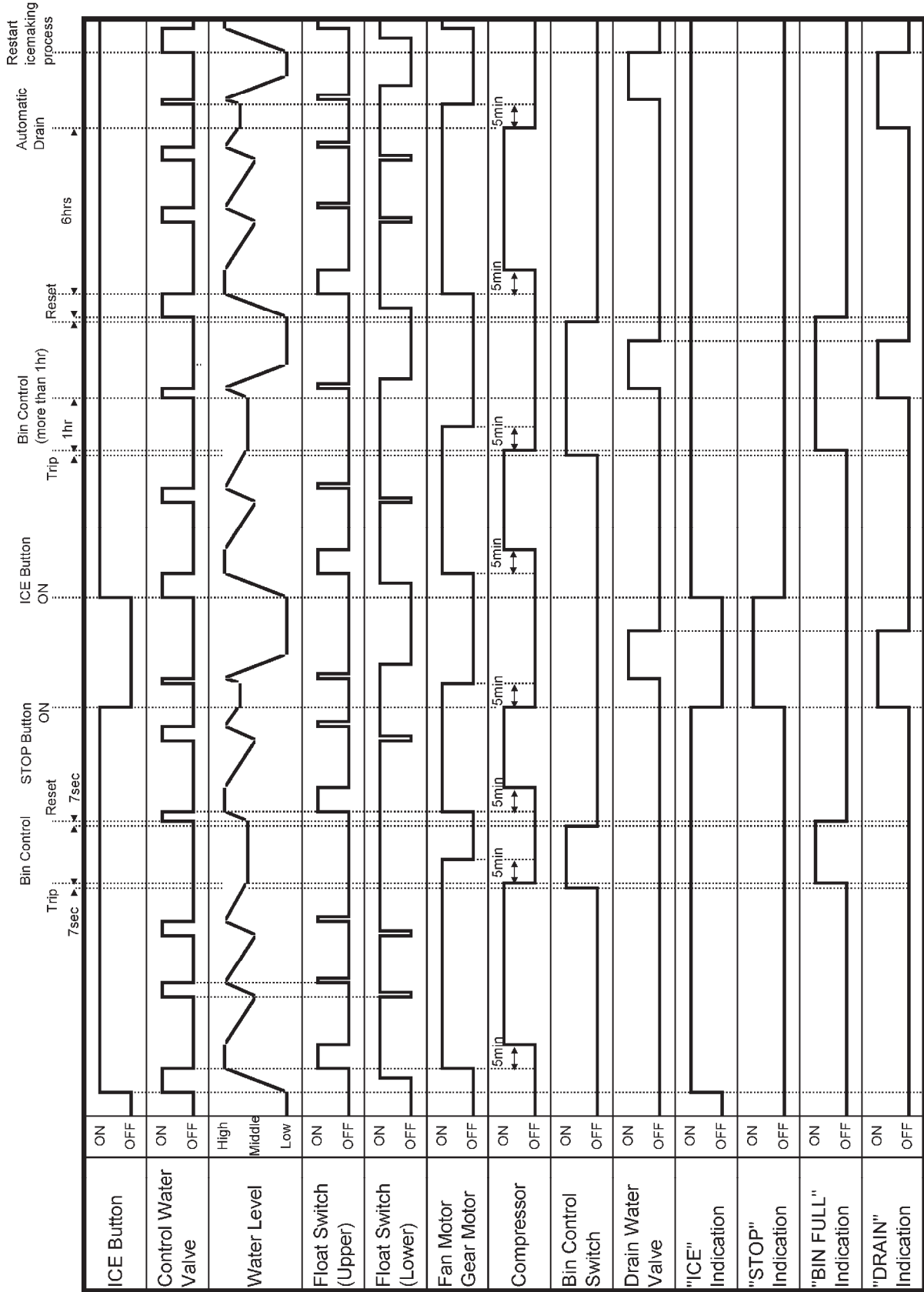

5. OPERATION BOARD

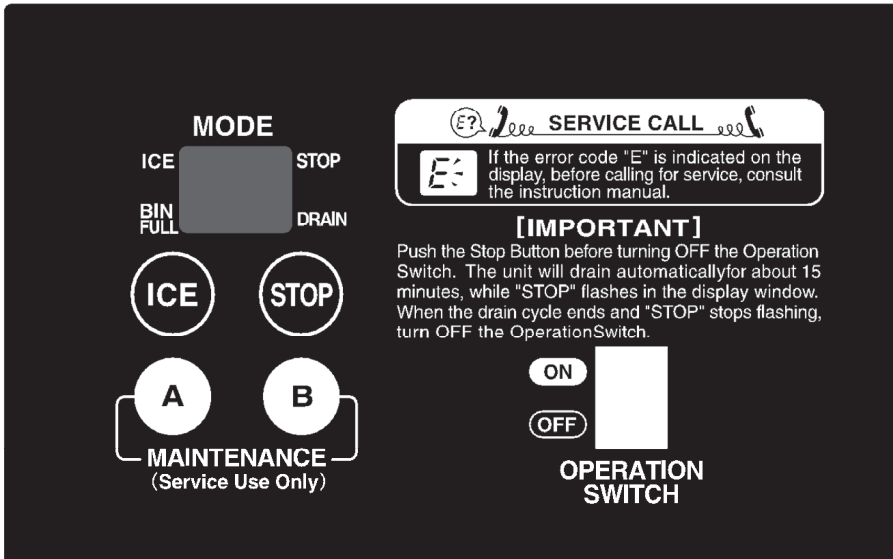

[a] OPERATION BUTTONS

ICE = When pressed in the STOP mode, the unit is supplied with water and starts icemaking operation.

STOP = When pressed in the ICE mode, the unit stops icemaking operation and drains.

MAINTENANCE A = Used for various maintenance operations.

MAINTENANCE B = Used for model code setting.

OPERATION SWITCH = Power supply for the icemaker. Move it to the "OFF" position to shut down the unit for a long time.

[b] SETTING MODEL NUMBER

The model number must be set at the time of replacement of the controller board. Check the model number specified on the wiring label. Improper setting may result in failure or inoperability.

- 1) Press and hold the maintenance B button, and move the operation switch to the "ON" position.
- 2) When the display shows "99", release the maintenance B button.
- 3) Press the stop button to increase the number, or press the ice button to decrease the number until it matches the model number on the wiring label.
- 4) Press the maintenance B button to complete the setting and start icemaking operation in the ice mode.
- 5) To check the model number, see next page.

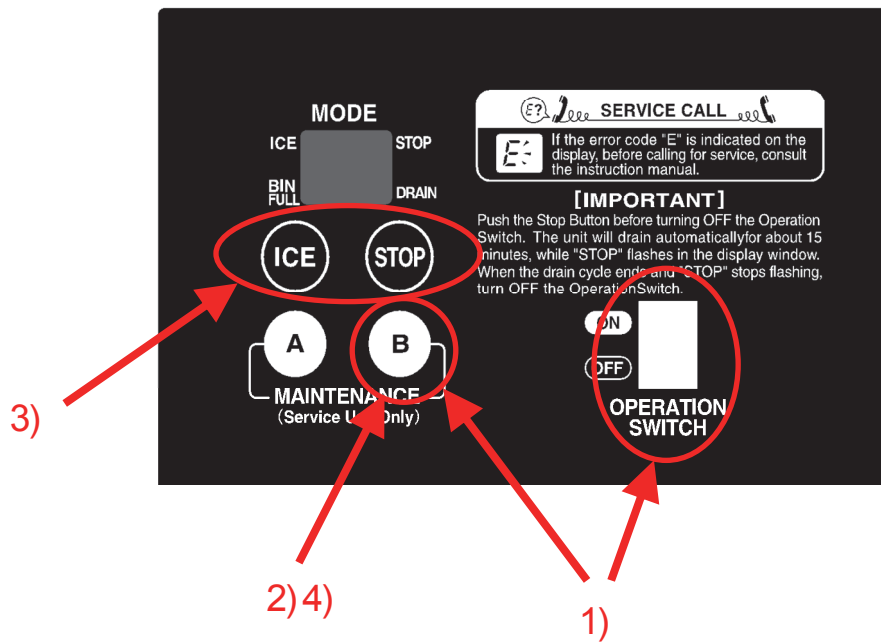

[c] DISPLAYING COMPRESSOR OPERATING HOURS, CYCLE TIME, MODEL NUMBER AND SOFTWARE VERSION

Press and hold the maintenance A button, and press the ice button. The display shows the following items one by one every time the ice button is pressed. This function is available in the ice or stop mode.

- Press and hold **MAINTENANCE A**
- ↓ **Compressor operating hours** on display ----- a)
 - Press **ICE**
 - ↓ **Cycle time** on display ----- b)
 - Press **ICE**
 - ↓ **Model number** on display ----- c)
 - Press **ICE**
 - ↓ **Software version** on display ----- d)
- Release **MAINTENANCE A**

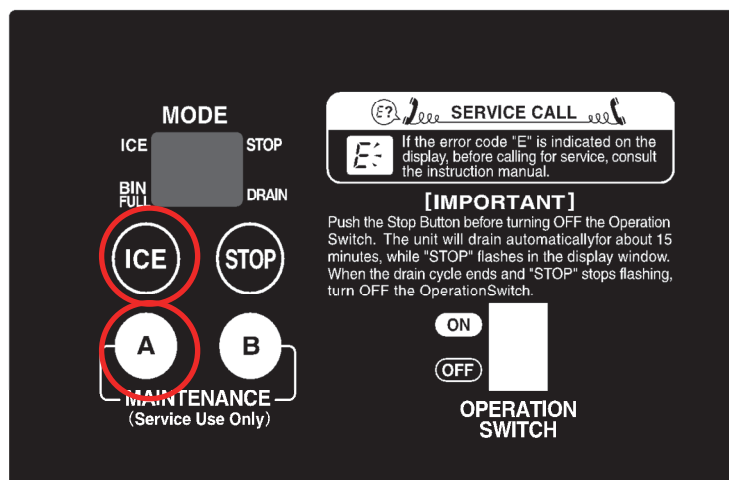

Note:

1. The display shows the next item if the ice button is pressed before one item appears in the display.
2. The display mode is cancelled if the maintenance A button is released.
3. The software version is displayed repeatedly while the maintenance A button is pressed. Release the maintenance A button to cancel the display mode.

a) Compressor Operating Hours

The display shows the compressor operating hours in six digits divided into three parts (two digits for 2 seconds each time).

Then, “- -” appears in the display (to show the end of the compressor operating hours display mode).

e.g. 3527 hours = “00”, “35”, “27”, “- -”

b) Cycle Time

The display shows the cycle time in four digits divided into two parts (first minutes then seconds, for 2 seconds each time) from the latest record (5 records at maximum).

Then, “- -” appears in the display (to show the end of the cycle time display mode).

If no cycle time is recorded, the display shows “- -” only.

Minutes are indicated as follows:

o	0 to 9	= 0 to 9 minutes
A	0 to 9	= 10 to 19 minutes
b	0 to 9	= 20 to 29 minutes
C	0 to 9	= 30 to 39 minutes
d	0 to 9	= 40 to 49 minutes
E	0 to 9	= 50 to 59 minutes

Seconds are indicated as

0 to 5

0 to 9

.

e.g.

o9

48

 = 9 minutes 48 seconds

b7

36

 = 27 minutes 36 seconds

By using the freeze cycle time, **approximate ice production capacity** can be calculated.

Series	Approximate ice production capacity (kg/d)
FM-80	60,000 / cycle time (sec)
FM-120	
CM-110	
FM-150	
CM-140	
FM-170	
FM-300	
FM-480	
FM-600	
FM-750	
FM-1000	
FM-1200	

This is just an approximate capacity. The actual capacity depends on ambient temperature, water temperature, voltage and frequency.

For accurate measurement, use a container to receive ice actually produced for 10 minutes, measure its weight, and calculate ice production per day. Repeat this three times to figure out the average.

c) Model Number

The display shows two digits.
 e.g. FM-750AKE(-N), FM-1000AKE(-N) = "05"

d) Software Version

The display shows the software version in six digits/symbols divided into three parts.
 e.g. Ver. 9-3-6 = "09", "-3", "-6"
 The indication is repeated until the maintenance A button is released.

[d] DISPLAYING ERROR LOG

Press and hold the maintenance A button, and press the stop button. The display shows the following items one by one every time the stop button is pressed. This function is available in the ice or stop mode.

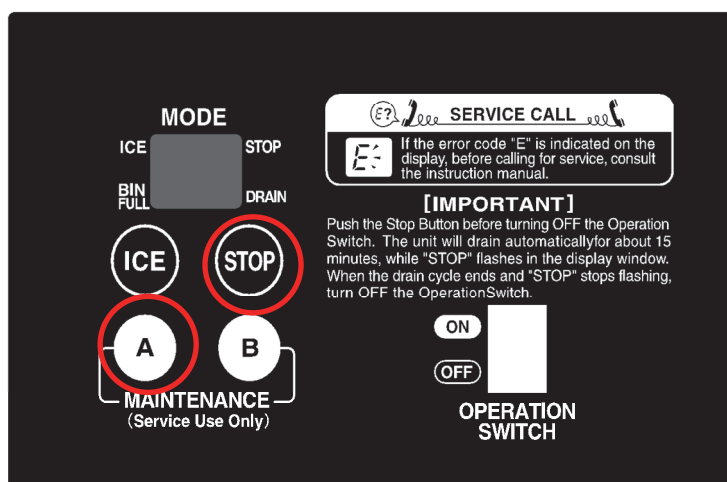
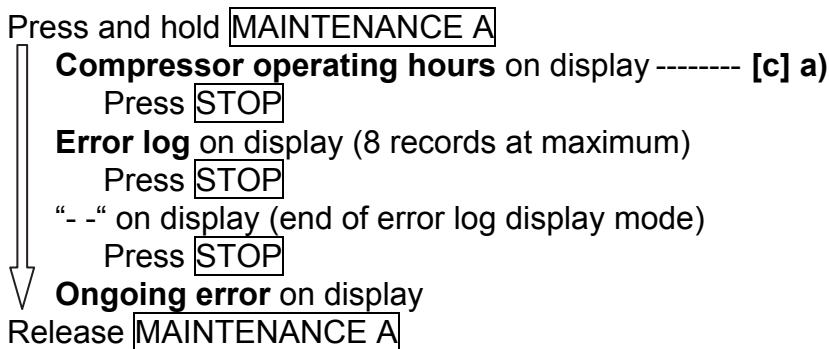

Note:

1. The display does not show the ongoing error even if the stop button is pressed while the error log is in the display. To display the ongoing error, press the stop button while "- -" is in the display to show the end of the error log display mode

[e] RESETTING ERROR LOG

With the operation switch in the “OFF” position, press and hold the stop and maintenance A buttons. Move the operation switch to the “ON” position. Release the buttons when the display shows the ice mode. Now the error log is reset. Do not reset more than necessary.

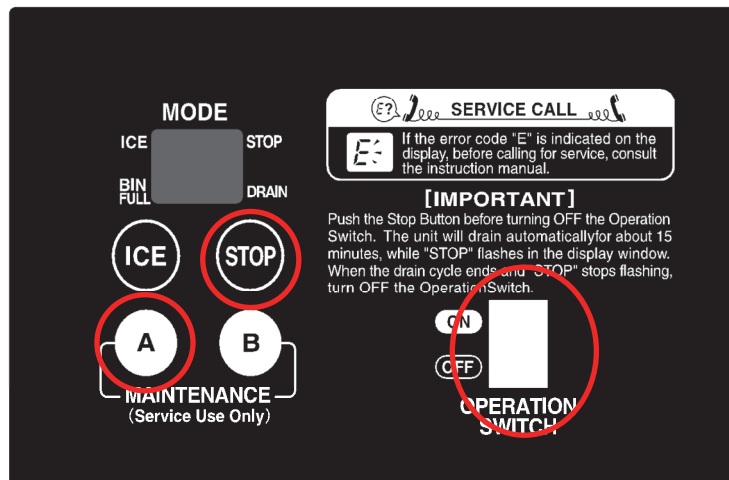

[f] RESETTING COMPRESSOR OPERATING HOURS

With the power switch turned off, press and hold the ice, stop and maintenance A buttons. Move the operation switch to the “ON” position. Release the buttons when the display shows the ice mode. Now the compressor operating hours are reset.

When the compressor starts in 15 seconds after the water supply cycle ends, the error log is not set to be updated. After resetting the compressor operating hours, move the operation switch to the “OFF” position, turn off the power switch, and turn it back on.

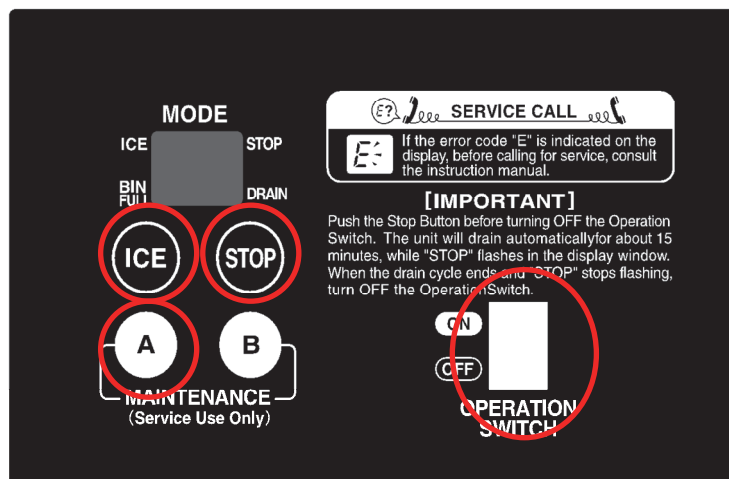

[g] REDUCING COMPRESSOR STARTING TIME

With the power switch turned off, press and hold the maintenance A button. Move the operation switch to the “ON” position. Release the button when the display shows the ice mode.

The compressor starts in 30 seconds after the water supply cycle ends

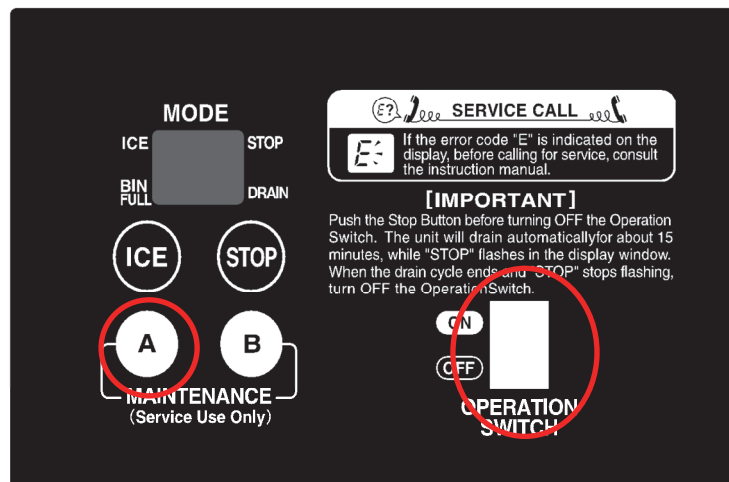

6. PROTECTORS

[a] INDICATION

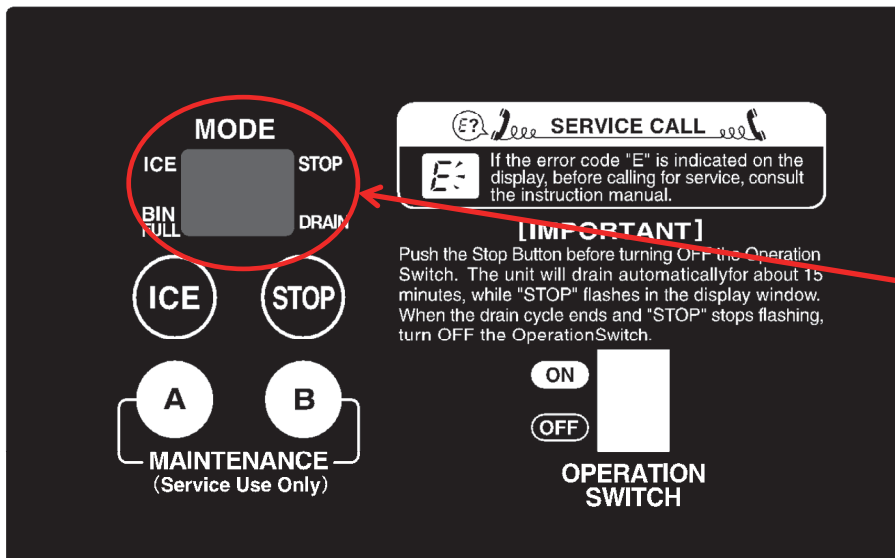

When an error occurs, "E_" or "c_" will appear in the display. Some of the "c_" errors are not displayed and must be checked by the error log.

When an operational error occurs, "E_" will appear and blink in the display on the operation board, and the icemaker will stop. When a service call is received, ask the user to check which error code is in the display. Then, see the error code table in "7. ERROR CODES" to locate the cause.

7. ERROR CODES

Interlock Errors

Code	Error	Condition	Operation	Reset	Check/Repair
E0	Icemaking Water Leak	c0 error occurs 2 times in a row.	Whole unit stops.	Power supply, Turn OFF - Turn ON	Water leak from water circuit (reservoir, inlet hose, outlet hose, hose joint, mechanical seal, flush water valve), float switch
E1	Low Ice Production	Icemaking cycle takes too long.	Whole unit stops.	Power supply, Turn OFF - Turn ON	Gas leak, control water valve not closing, vapor lock, freeze, float switch
E2	Float Switch Error	With flush water valve OFF, float switch trips at both upper and lower float levels for 2 seconds.	Whole unit stops.	Power supply, Turn OFF - Turn ON	Float switch
E3	Gear Motor Error or Gear Motor Sensor Circuit Open	Gear motor is ON with rotation sensor or current sensor circuit open.	Whole unit stops.	Power supply, Turn OFF - Turn ON	Rotation sensor, current sensor
		Gear motor relay is ON with gear motor protective circuit detector OFF.			Gear motor protective circuit (TPO, overload, etc.), gear motor relay
E4	Abnormal High Side Pressure	c2 error occurs 5 times in 1 hour of compressor operation.	E4 blinks.	N/A	Fan motor, cooling water circuit, refrigeration circuit, condenser clogged, water supply, installation conditions
E5	Gear Motor Drive Element Error	Gear motor is OFF on controller board while rotation sensor signals gear motor rotation or current flows.	Whole unit stops.	Power supply, Turn OFF - Turn ON	Miswiring, gear motor magnet switch or relay Replace controller board.
		Gear motor relay is OFF with gear motor protective circuit detector ON.			
E8	Discharge Pipe Temperature Error	Discharge pipe thermostat is OFF.	Whole unit stops.	Power supply, Turn OFF - Turn ON	Gas leak, compressor cooling fan failure
EA	Water Thermistor Circuit Open	Water thermistor circuit is open.	EA blinks.	N/A	Water thermistor
Eb	Condenser Thermistor Circuit Open	Condenser thermistor circuit is open.	Whole unit stops.	Power supply, Turn OFF - Turn ON	Condenser thermistor
EC	Evaporator Outlet Thermistor Circuit Open	Evaporator outlet thermistor circuit is open.	Whole unit stops.	Power supply, Turn OFF - Turn ON	Evaporator outlet thermistor
EE	Gear Motor Error	Rotation sensor detects reversing.	Whole unit stops.	Power supply, Turn OFF - Turn ON	Gear motor locked, hunting or overloaded, supply voltage, high ambient temperature
		c5 error occurs 5 times.			
EF	Abnormal Low Voltage	c3 error occurs 3 times in 24 hours.	Whole unit stops.	Power supply, Turn OFF - Turn ON	Supply voltage
EH	Discharge Pipe Thermistor Circuit Open	Discharge pipe thermistor circuit is open.	EH blinks.	N/A	Discharge pipe thermistor
EL	Bin Control Switch Error	Bin control protective switch trips.	Whole unit stops.	Power supply, Turn OFF - Turn ON	Bin control switch

Code	Error	Condition	Operation	Reset	Check/Repair
En	Low Voltage Sensing Transformer Circuit Open	Low voltage sensing transformer circuit is open.	Whole unit stops.	Power supply, Turn OFF - Turn ON	Low voltage sensing Transformer
EU	Controller Board Error	Controller board IC fails.	Whole unit stops.	Power supply, Turn OFF - Turn ON	Replace controller board.
None	Electric Leak Short Circuit	Electric leak or overcurrent.	Whole unit stops.	Power supply, Turn OFF - Turn ON Replace fuse	Electric leak, fuse

Non-Interlock Errors

Code	Error	Condition	Operation	Reset	Check/Repair
CM Time “- .”	Microcomputer Read/Write Error	Microcomputer fails to read/write properly.	Memory circuit not available.	Replace controller board.	Error records and compressor operating hours not available on display
c0	Icemaking Water Leak	After initial water supply, float switch trips at lower float level within 5 minutes after gear motor starts and before compressor starts.	Whole unit stops. Flush water valve turns ON for 1 second, then turns OFF. Unit restarts.	Error record only.	Water leak from water circuit (reservoir, hoses, mechanical seal, flush water valve), float switch
c1	Low Water	Water supply continues for more than 90 seconds, or float switch trips at lower float level and does not reset for more than 60 seconds after water supply.	Whole unit stops until reservoir fills up. Only control water valve operates intermittently for 5 minutes.	Automatically resets after reservoir fills up.	Water supply interruption, control water valve not opening, flush water valve not closing, float switch, water leak
c2	Abnormal High Side Pressure	Pressure switch stays OFF for 5 seconds or condenser thermistor reads higher than set point for 5 seconds.	Whole unit stops.	Automatically resets after pressure switch turns ON or condenser thermistor reads lower than set point.	Condenser clogged, cooling water circuit, refrigeration circuit
c3	Abnormal Low Voltage	Voltage stays below setting for more than 1 second with compressor ON and control water valve OFF.	Whole unit stops.	Automatically resets after voltage stays above reset setting for 2 minutes.	Supply voltage
c4	Drain Error	Float switch trips at upper float level in 10 minutes after flush water valve turns ON.	N/A	Error record only.	Flush water valve not opening, control water valve not closing
c5	Gear Motor Error	Rotation rate reduces. While gear motor is running, voltage detection signal is not input to controller board.	Whole unit stops.	Automatically resets after 30 minutes.	Gear motor overloaded
c7	Evaporator Outlet Temperature Decrease	Evaporator outlet temperature decreases.	Indication only.	Automatically resets.	Evaporator inside not clean, extruding head not clean, heater circuit open

8. PERFORMANCE DATA

[a] FM-150KE, FM-150KE-50

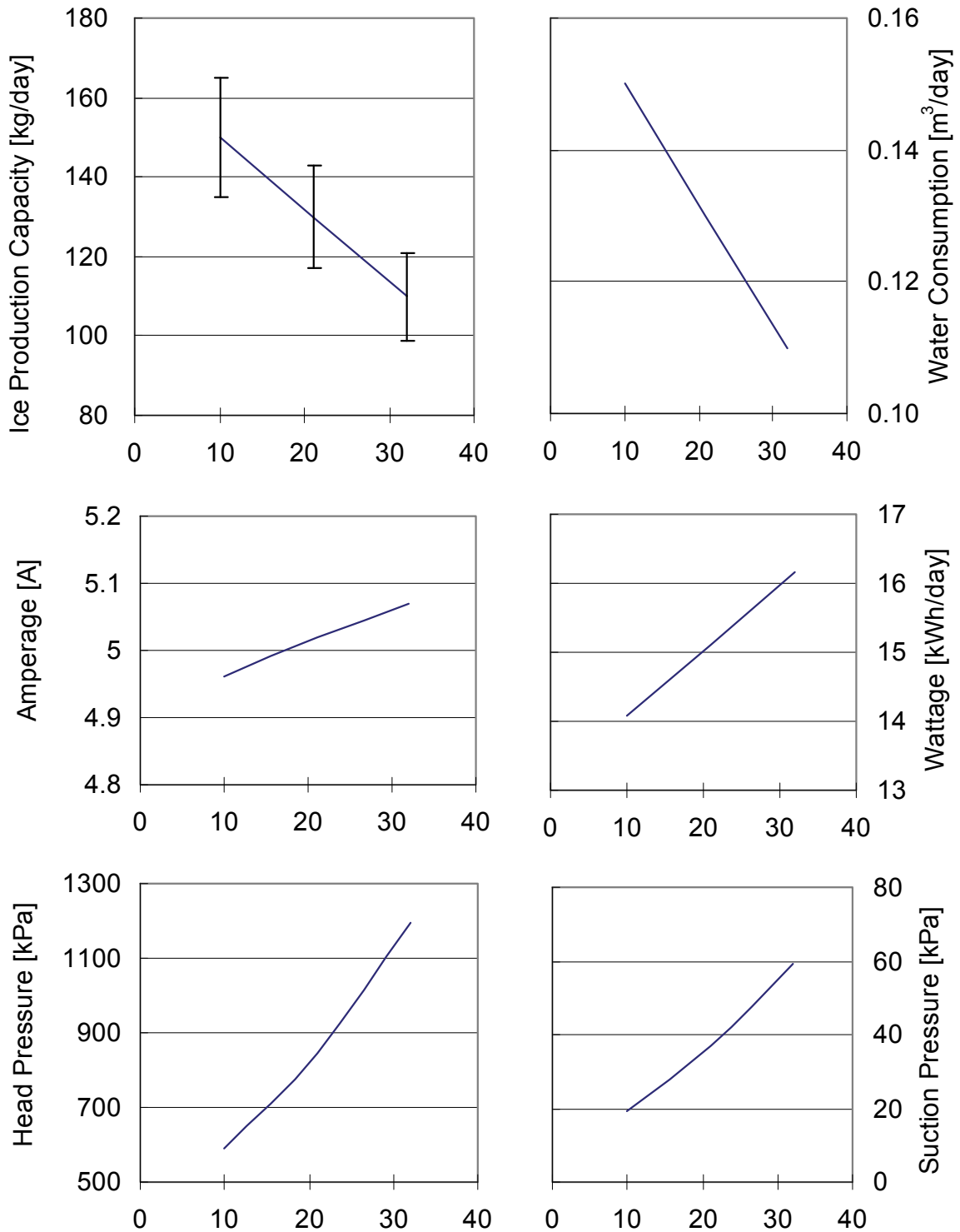

The horizontal axis shows the ambient temperature.
It refers to the data of at/wt=10/10,21/15,32/21,40/35.

[b] FM-150KE-N, FM-150KE-50-N

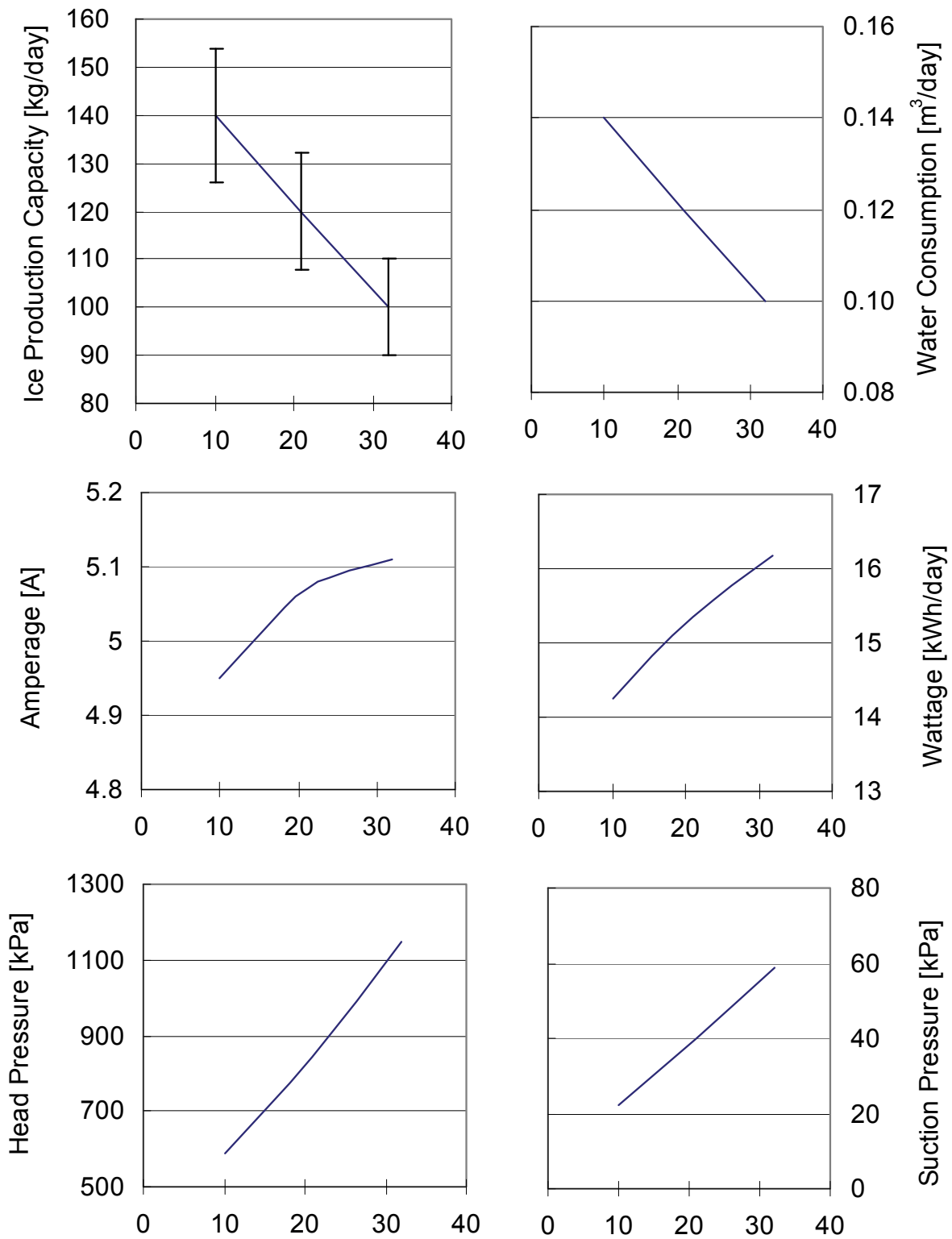

The horizontal axis shows the ambient temperature.
 It refers to the data of at/wt= 10/10,21/15,32/21,40/35.

[c] CM-140KE

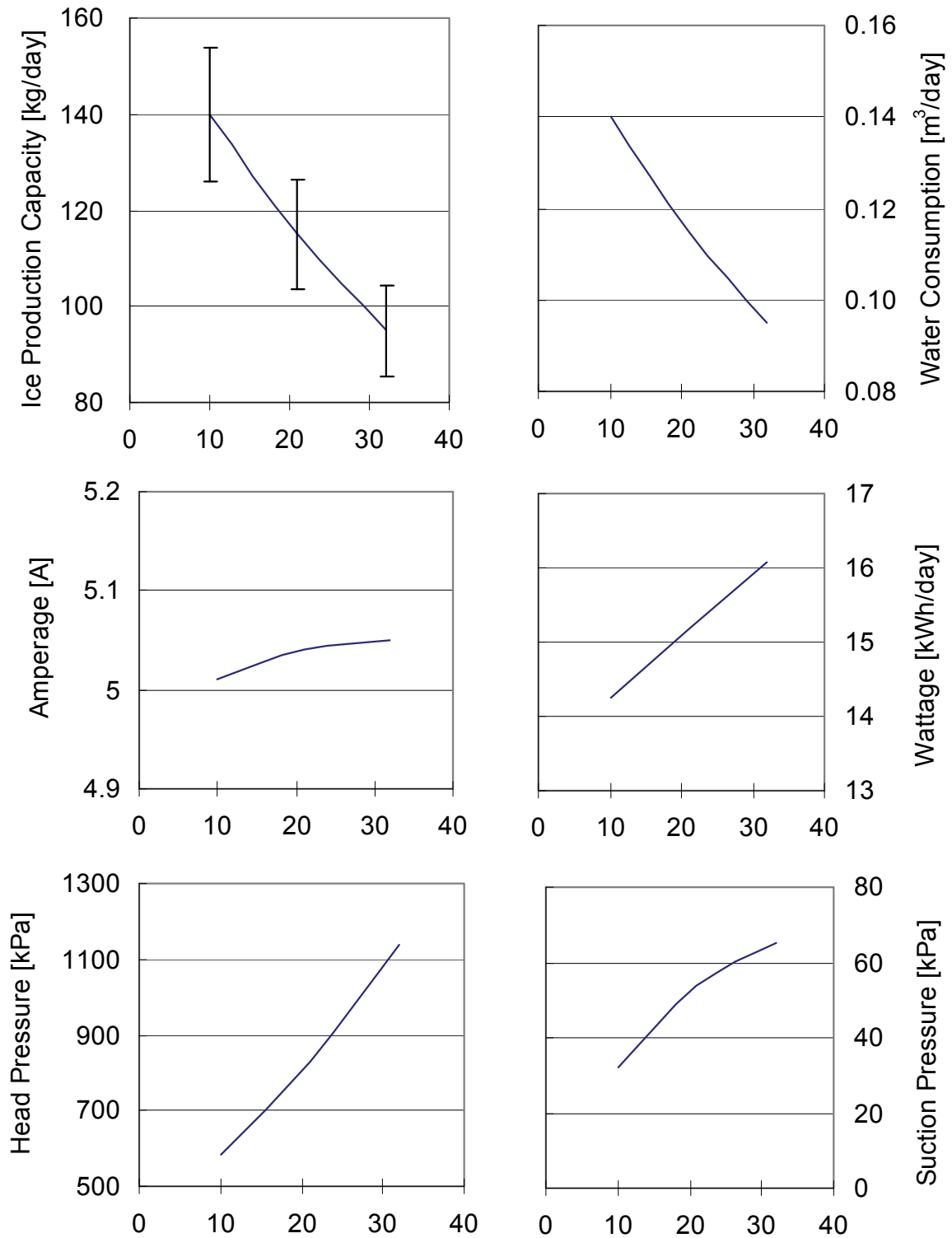

The horizontal axis shows the ambient temperature.
 It refers to the data of at/wt=10/10,21/15,32/21,40/35.

[d] FM-120KE

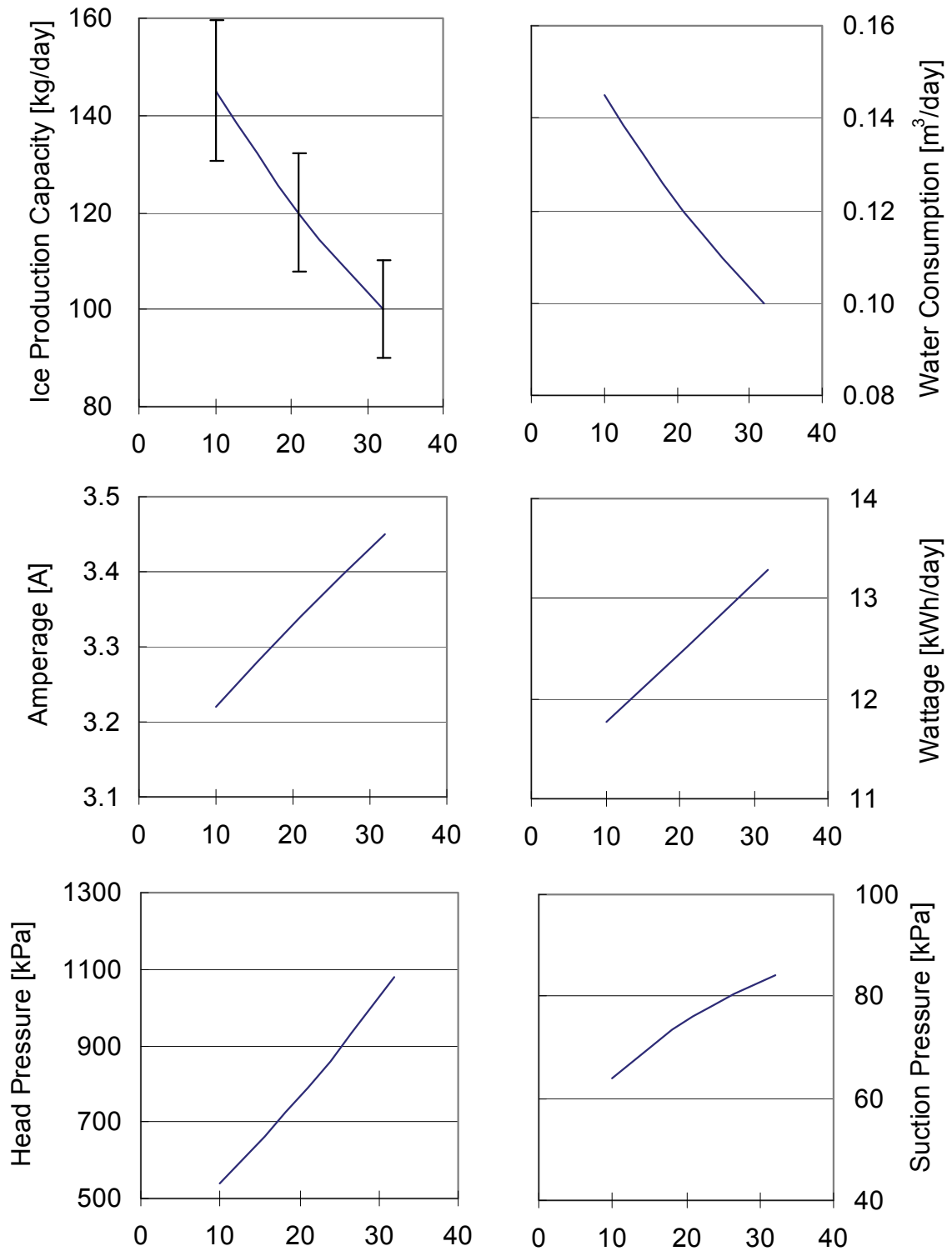

The horizontal axis shows the ambient temperature.
It refers to the data of at/wt=10/10,21/15,32/21,40/35.

[e] CM-110KE-50

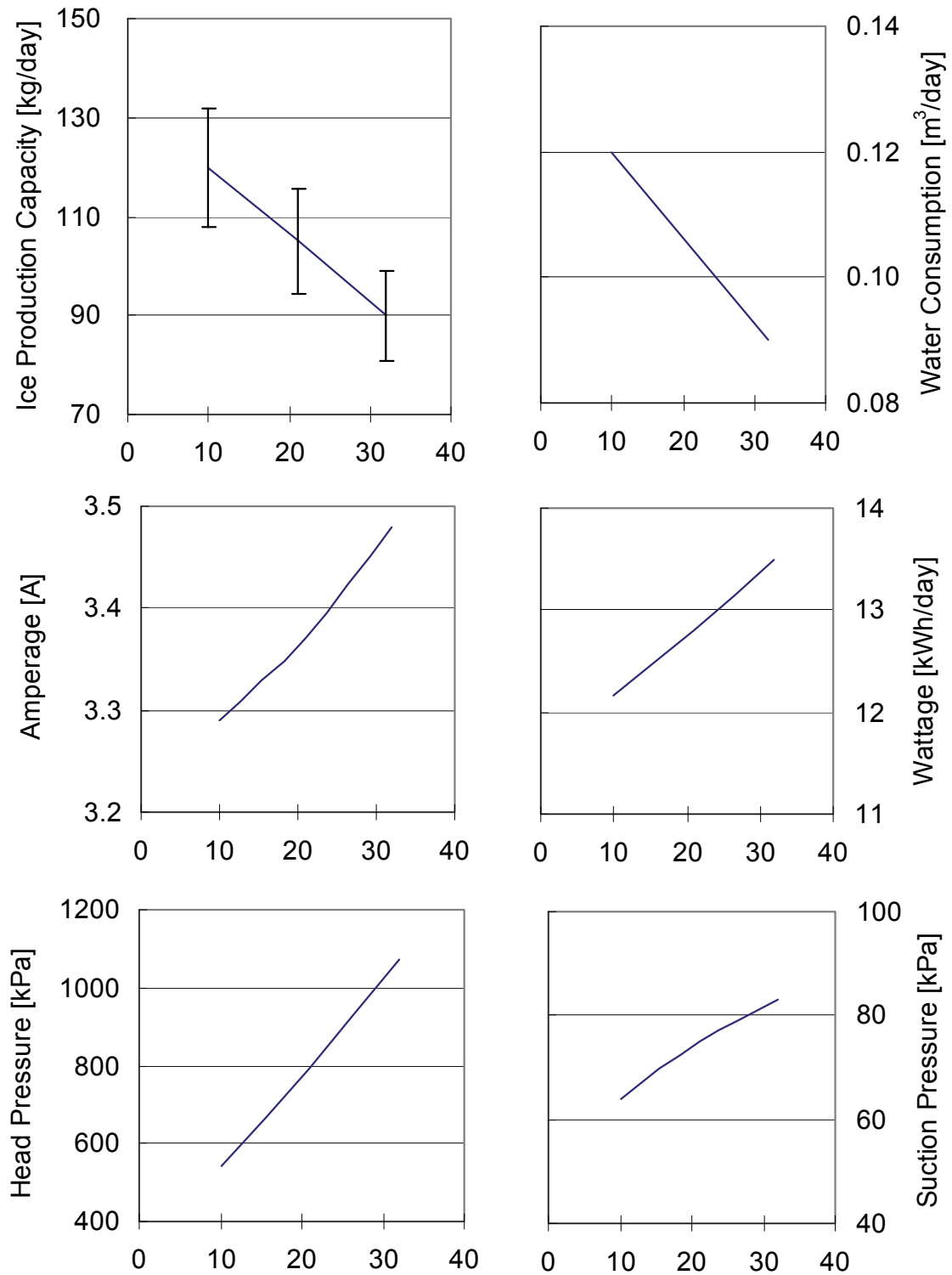

The horizontal axis shows the ambient temperature.
It refers to the data of at/wt=10/10,21/15,32/21,40/35.

[f] FM-80KE

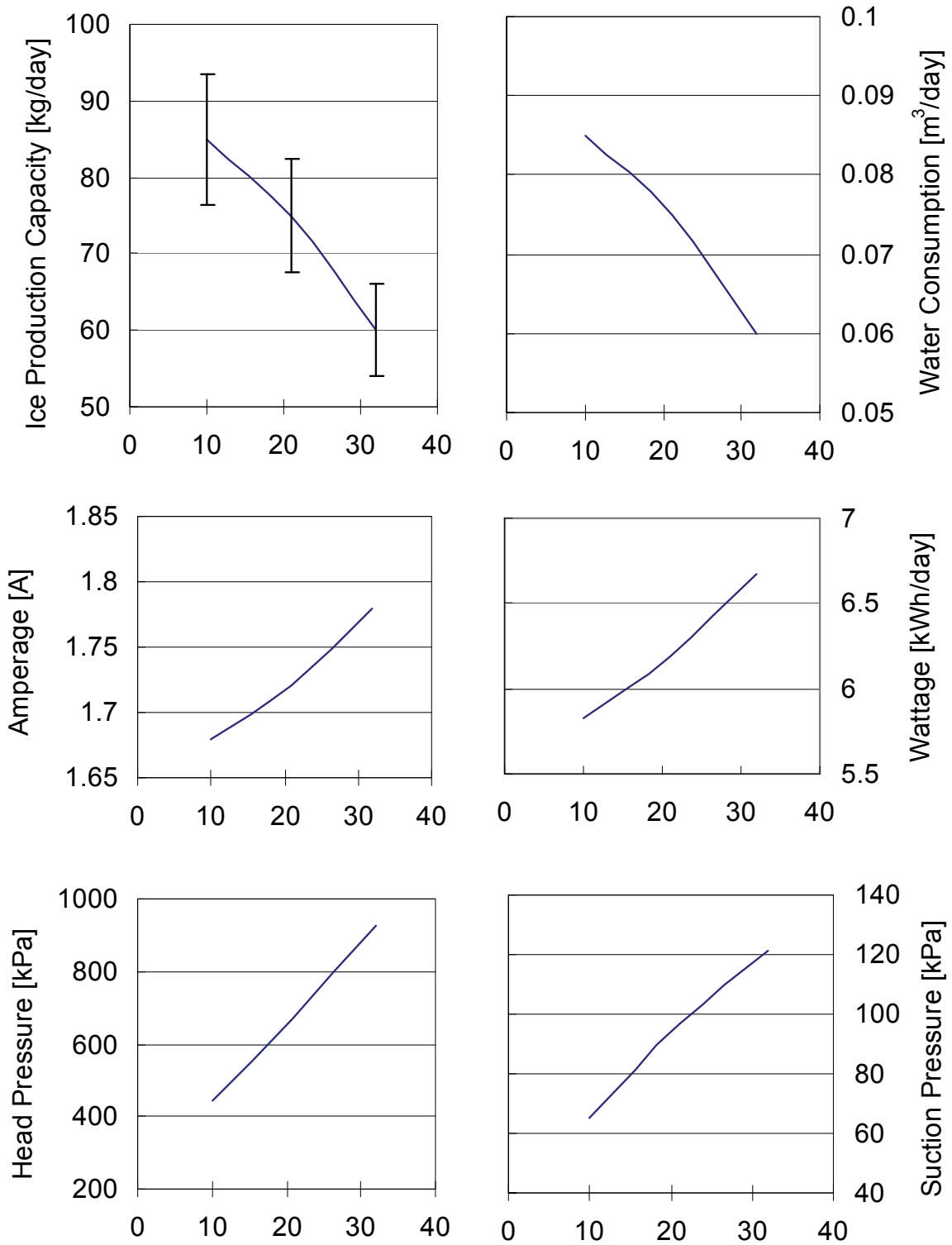

The horizontal axis shows the ambient temperature.
 It refers to the data of at/wt=10/10,21/15,32/21,40/35.

[g] FM-80KE-N

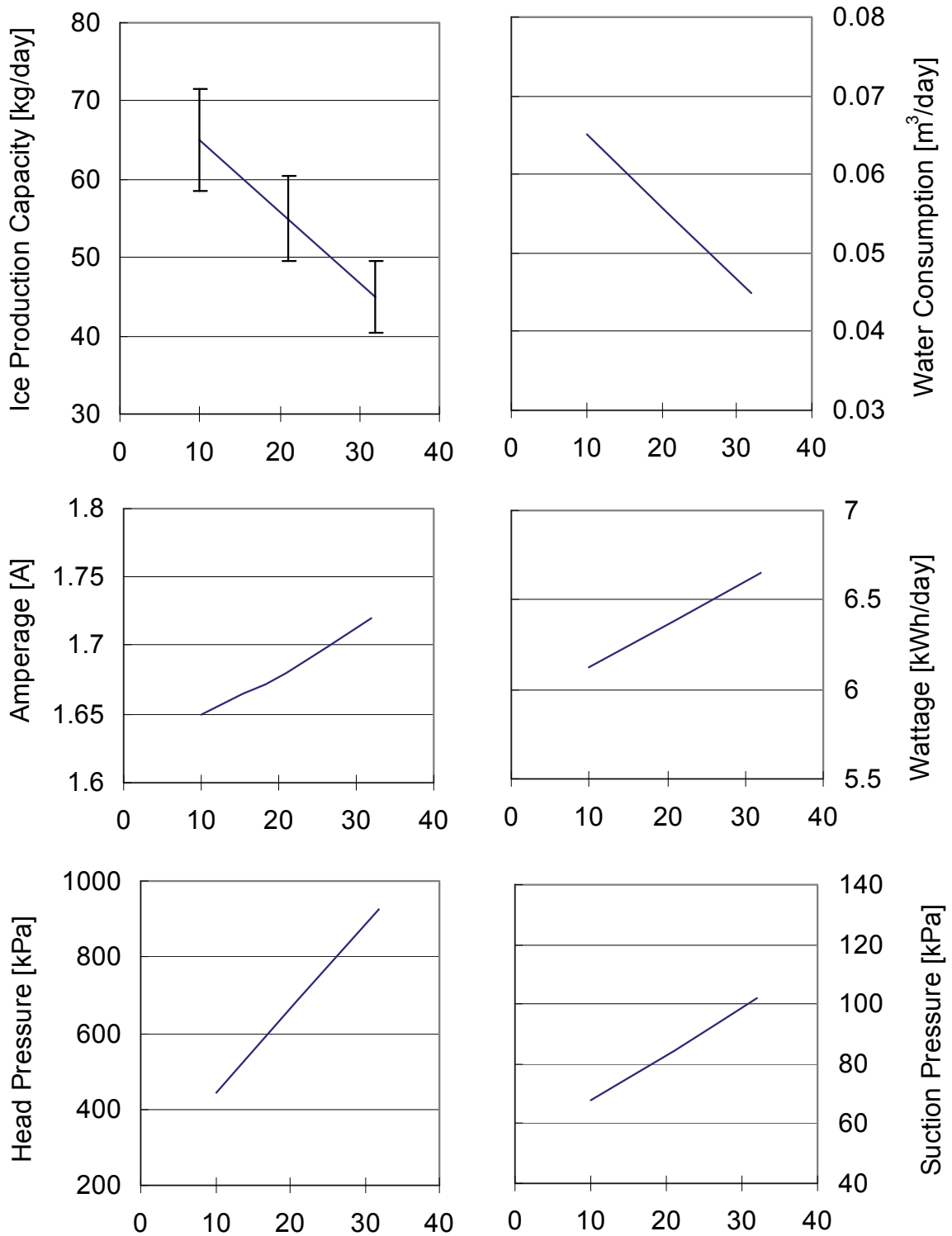

The horizontal axis shows the ambient temperature.
 It refers to the data of at/wt=10/10,21/15,32/21,40/35.

IV. SERVICE DIAGNOSIS

Display error records by operating the operation board (see “III. 5. [d] DISPLAYING ERROR LOG”). Check for a possible cause and service the unit.

1. NO ICE PRODUCTION

PROBLEM	POSSIBLE CAUSE		REMEDY
[1] The icemaker will not start.	a) Power supply	1. OFF position.	1. Move to ON position.
		2. Loose connections.	2. Tighten.
		3. Bad contacts.	3. Check for continuity and replace.
		4. Blown fuse.	4. Replace.
		5. Voltage too low.	5. Get recommended voltage.
	b) Fuse	1. Blown out. No indication on operation board.	1. Locate and resolve the cause of short circuit (ex. control water valve, flush water valve), and replace.
	c) Transformer receptacle	1. Disconnected.	1. Connect.
	d) Operation switch	1. OFF position.	1. Move to ON position.
		2. Bad contacts.	2. Check for continuity and replace.
	e) Transformer	1. Coil winding opened.	1. Replace.
	f) Water valve	1. Coil winding opened.	1. Replace.
	g) Water supply tap	1. Closed.	1. Open.
		2. Water failure.	2. Wait till water is supplied.
h) Plug and receptacle (control box)	1. Disconnected.	1. Connect.	
	2. Terminal out of plug or receptacle.	2. Insert terminal back in position.	
i) Reed switch (spout)	1. Tripped.	1. See 1 - [3] - a).	
j) Overload protector	1. Tripped.	1. Reset.	
k) Model number	1. Incorrect.	1. Set correct number. See “III. 5. [b] SETTING MODEL NUMBER”.	
[2] Water does not stop, and the icemaker will not start.	a) Water control relay (controller board)	1. Contacts fused.	1. Replace controller board.
		2. Coil winding opened.	2. Replace controller board.
	b) Float switch	1. Bad contacts.	1. Check for continuity and replace.
		2. Float does not move freely.	2. Clean or replace.
	c) Flush water valve	1. Valve seat clogged and water leaking.	1. Clean or replace.
	d) Hoses	1. Disconnected.	1. Connect.
e) Mechanical seal	1. Water leaks.	1. Replace.	
f) Reservoir	1. Cracked.	1. Replace.	
[3] Water has been supplied, but the icemaker will not start.	a) Bin control	1. Bad contacts.	1. Check for continuity and replace.
	b) Gear motor protector (thermal breaker)	1. Tripped.	1. Find out the cause, resolve it, and press reset button on motor protector.
	c) Controller board	1. Defective.	1. Replace.

PROBLEM	POSSIBLE CAUSE	REMEDY	
[3] (Continued)	d) Pressure switch, condenser thermistor	1. Dirty condenser fins.	1. Clean.
		2. Ambient temperature too warm.	2. Check for recommended temperature.
		3. Fan not rotating.	3. Replace.
		4. Condenser water pressure too low or off.	4. Check and get recommended pressure.
		5. Water regulating valve clogged.	5. Clean.
		6. Refrigerant overcharged.	6. Recharge.
		7. Refrigerant line or components plugged.	7. Clean and replace drier.
		8. Bad contacts.	8. Check for continuity and replace.
		9. Loose connections.	9. Tighten.
	e) Thermostat (water-cooled model)	1. Ambient temperature too warm.	1. Check for recommended temperature.
		2. Compressor cooling fan motor defective.	2. Replace.
		3. Bad contacts.	3. Check for continuity and replace.
		4. Loose connections.	4. Tighten.
f) Gear motor protect relay	1. Coil winding opened.	1. Replace.	
	2. Bad contacts.	2. Check for continuity and replace.	
[4] Gear motor starts, but compressor will not start or operates intermittently.	a) X4 relay (controller board)	1. Bad contacts.	1. Check for continuity and replace controller board.
		2. Coil winding opened.	2. Replace controller board.
	b) X6 relay	1. Bad contacts.	1. Check for continuity and replace X6 relay.
		2. Coil winding opened.	2. Replace X6 relay.
	c) Compressor	1. Loose connections.	1. Tighten.
		2. Motor winding opened or earthed.	2. Replace.
		3. Motor protector tripped.	3. Find out the cause of overheat or overcurrent.
	d) Power supply	1. Circuit ampacity too low.	1. Install a larger-sized conductor.
	e) Controller board	1. Defective.	1. Replace
	f) Start capacitor or run capacitor	1. Defective.	1. Replace
[5] Gear motor and compressor start, but no ice is produced.	a) Refrigerant line	1. Gas leaks.	1. Check for leaks with a leak detector. Reweld leak, replace drier and charge with refrigerant. The amount of refrigerant is marked on nameplate or label.
		2. Refrigerant line clogged.	2. Replace the clogged component.

2. LOW ICE PRODUCTION

PROBLEM	POSSIBLE CAUSE		REMEDY
[1] Low ice production	a) Refrigerant line	1. Gas leaks.	1. See 1 - [5] - a).
		2. Refrigerant line clogged.	2. Replace the clogged component.
		3. Overcharged.	3. Recharge.
	b) High-side pressure too high	1. Dirty air filter or condenser.	1. Clean.
		2. Ambient or condenser water temperature too warm.	2. Check for recommended temperature.
		3. Condenser water pressure too low or off.	3. Check and get recommended pressure.
		4. Fan rotating too slow.	4. Replace.
		5. Water regulating valve clogged.	5. Clean.
		6. Bad ventilation.	6. Remove anything blocking vents.
		7. Less than specified clearance at rear, sides and top.	7. Allow proper clearance for ventilation.
c) Expansion valve (not adjustable)	1. Low-side pressure exceeding the limit.	1. Replace.	
d) Evaporator	1. Evaporator pipe crushed.	1. Replace.	

3. OTHERS

PROBLEM	POSSIBLE CAUSE		REMEDY
[1] Abnormal noise	a) Fan motor (condenser unit)	1. Bearing worn out.	1. Replace.
		2. Fan blade deformed.	2. Replace fan blade.
		3. Fan blade does not move freely.	3. Replace.
	b) Compressor	1. Bearings worn out, or cylinder valve defective.	1. Replace.
		2. Mounting pad out of position.	2. Reinstall.
	c) Refrigerant lines	1. Rub or touch lines or other surfaces.	1. Replace.
	d) Gear motor (ice making)	1. Bearing or gear wear/damage.	1. Replace.
	e) Evaporator	1. Low-side pressure too low.	1. See if expansion valve bulb is mounted properly, and replace the valve if necessary.
		2. Scale on inside wall of freezing cylinder.	2. Remove auger. Use a solution of lime removing cleaner to clean periodically. If water is found to surpass the following levels, install a conditioner. Hardness 50 ppm Silica 30 ppm
	f) Heater	1. Defective.	1. Replace.
	g) CPR (condenser unit)	1. Internal leaks.	1. Replace.

PROBLEM	POSSIBLE CAUSE		REMEDY
[2] Overflow from reservoir (Water does not stop.)	a) Water supply	1. Water pressure too high.	1. Install a pressure reducing valve.
	b) Water valve	1. Diaphragm does not close.	1. Clean or replace.
	c) Float switch	1. Bad contacts.	1. Check for continuity and replace.
[3] Gear motor protector operates frequently.	a) Power supply voltage	1. Too high or too low.	1. Connect the unit to a power supply of proper voltage.
	b) Evaporator assy	1. Bearings or auger worn out.	1. Replace bearing or auger.

V. REMOVAL AND REPLACEMENT

1. SERVICE FOR REFRIGERANT LINES

[a] SERVICE INFORMATION

1) Allowable Compressor Opening Time and Prevention of Lubricant Mixture [R404A/R134A]

The compressor must not be opened more than 15 minutes in replacement or service. Do not mix lubricants of different compressors even if both are charged with the same refrigerant, except when they use the same lubricant.

2) Treatment for Refrigerant Leak [R404A/R134A]

If a refrigerant leak occurs in the low side of an ice maker, air may be drawn in. Even if the low side pressure is higher than the atmospheric pressure in normal operation, a continuous refrigerant leak will eventually lower the low side pressure below the atmospheric pressure and will cause air suction. Air contains a large amount of moisture, and ester oil easily absorbs a lot of moisture. If an ice maker charged with R404A/R134A has possibly drawn in air, the drier must be replaced. Be sure to use a drier designed for R404A/R134A.

3) Handling of Handy Flux [R404A/R134A]

Repair of the refrigerant circuit requires brazing. It is no problem to use the same handy flux that has been used for the current refrigerants. However, its entrance into the refrigerant circuit should be avoided as much as possible.

4) Oil for Processing of Copper Tubing [R404A/R134A]

When processing the copper tubing for service, wipe off oil, if any used, by using alcohol or the like. Do not use too much oil or let it into the tubing, as wax contained in the oil will clog the capillary tubing.

5) Service Parts for R404A/R134A

Some parts used for refrigerants other than R404A/R134A are similar to those for R404A/R134A. But never use any parts unless they are specified for R404A/R134A because their endurance against the refrigerant has not been evaluated. Also, for R404A/R134A, do not use any parts that have been used for other refrigerants. Otherwise, wax and chlorine remaining on the parts may adversely affect R404A/R134A.

6) Replacement Copper Tubing [R404A/R134A]

The copper tubes currently in use are suitable for R404A/R134A. But do not use them if oily inside. The residual oil in copper tubes should be as little as possible. (Low residual oil type copper tubes are used in the shipped units.)

7) Evacuation, Vacuum Pump and Refrigerant Charge [R404A/R134A]

Never allow the oil in the vacuum pump to flow backward. The vacuum level and vacuum pump may be the same as those for the current refrigerants. However, the rubber hose and gauge manifold to be used for evacuation and refrigerant charge should be exclusively for R404A/R134A.

8) Refrigerant Leak Check

Refrigerant leaks can be detected by charging the unit with a little refrigerant, raising the pressure with nitrogen and using an electronic detector. Do not use air or oxygen instead of nitrogen for this purpose, or rise in pressure as well as in temperature may cause R404A/R134A to suddenly react with oxygen and explode. Be sure to use nitrogen to prevent explosion.

[b] REFRIGERANT RECOVERY

The refrigerant must be recovered if required by an applicable law. A low-side access valve is provided in the unit (modular type only). Recover the refrigerant from the access valve, and store it in a proper container. Do not discharge the refrigerant into the atmosphere. When replacing the drier, take the opportunity to also fit a low-side access valve (self-contained type only) and a high-side access valve for ease of charging liquid refrigerant.

[c] EVACUATION AND RECHARGE

R134a models

- 1) Attach a charging hose of a gauge manifold to a vacuum pump and the low-side access valve (to be fitted by service personnel for self-contained type).
- 2) Open the low-side valve on the gauge manifold, and turn on the vacuum pump.
- 3) Allow the vacuum pump to pull down to a 760 mmHg vacuum. Evacuating period depends on the pump capacity.
- 4) Close the low-side valve on the gauge manifold.
- 5) Disconnect the vacuum pump, and attach a refrigerant charging cylinder to accurately weigh in the liquid charge. Remember to purge any air from the charging hose. See the nameplate for the required refrigerant charge.
- 6) Open the low-side valve on the gauge manifold and the valve on the charging cylinder.
- 7) When no more refrigerant is drawn in, turn on the icemaker. When the required amount of refrigerant has been charged, close the valve on the charging cylinder and turn off the icemaker.
- 8) Close the low-side valve on the gauge manifold.

- 9) Disconnect the charging hose from the access valve. Always cap the access valve to prevent a refrigerant leak.
- 10) Always thoroughly leak test all joints and valve caps.
- 11) Avoid charging large quantities of liquid into the low side in case of damage to the compressor.

R404A models

- 1) Attach charging hoses of a gauge manifold to a vacuum pump, the low-side access valve and the high-side access valve (to be fitted by service personnel).
- 2) Open the low-side and high-side valves on the gauge manifold, and turn on the vacuum pump.
- 3) Allow the vacuum pump to pull down to a 760 mmHg vacuum. Evacuating period depends on the pump capacity.
- 4) Close the low-side and high-side valves on the gauge manifold.
- 5) Disconnect the vacuum pump, and attach a refrigerant charging cylinder to accurately weigh in the liquid charge. Remember to purge any air from the charging hose. See the nameplate for the required refrigerant charge.
- 6) Open the high-side valve on the gauge manifold and the valve on the charging cylinder.

Note: Always charge in the liquid stage, as many refrigerants are blends and vapour charging will affect the blend consistency.
- 7) When no more refrigerant is drawn in, turn on the icemaker. When the required amount of refrigerant has been charged, close the valve on the charging cylinder and turn off the icemaker.
- 8) Close the high-side valve on the gauge manifold.
- 9) Disconnect the charging hoses from the access valves. Always cap the access valves to prevent a refrigerant leak.
- 10) Always thoroughly leak test all joints and valve caps.
- 11) Avoid charging large quantities of liquid into the low side in case of damage to the compressor.

2. BRAZING

DANGER

1. Refrigerant R404A/R134A itself is not flammable, explosive and poisonous. However, when exposed to an open flame, R404A/R134A creates phosgene gas, hazardous in large amounts.
2. Always recover the refrigerant and store it in a proper container, if required by an applicable law. Do not discharge the refrigerant into the atmosphere.
3. Do not use silver alloy or copper alloy containing arsenic.
4. In its liquid state, the refrigerant can cause frostbite because of the low temperature.

3. COMPRESSOR

IMPORTANT

Always install a new drier every time the sealed refrigeration system is opened. Do not replace the drier until after all other repair or replacement has been made.

- 1) Disconnect the power source.
- 2) Remove the panels.
- 3) Remove the terminal cover on the compressor, and disconnect the compressor wiring.
- 4) Recover the refrigerant and store it in a proper container, if required by an applicable law (See "1. [b] REFRIGERANT RECOVERY").
- 5) Remove the discharge, suction and access pipes from the compressor using brazing equipment.

WARNING

When repairing a refrigerant system, be careful not to let the burner flame contact any electrical wires or insulation.

- 6) Remove the bolts and rubber grommets.
- 7) Slide and remove the compressor. Unpack the new compressor package. Install the new compressor.
- 8) Attach the rubber grommets of the previous compressor.
- 9) Clean the suction and discharge pipes with an abrasive cloth/paper.

- 10) Place the compressor in position, and secure it using the bolts and washers.
- 11) Remove plugs from the discharge, suction and access pipes.
- 12) Braze the access, suction and discharge pipes (Do not change this order) with nitrogen gas flowing at the pressure of 0.2 - 0.3 bar.
- 13) Install the new drier (See "4. DRIER").
- 14) Check for leaks using nitrogen gas (10 bar) and soap bubbles.
- 15) Evacuate the system, and charge it with refrigerant. See the nameplate for the required refrigerant charge (See "1. [c] EVACUATION AND RECHARGE").
- 16) Connect the terminals to the compressor, and replace the terminal cover in its correct position.
- 17) Refit the panels in their correct position.
- 18) Connect the power source.

4. DRIER

IMPORTANT

Always install a new drier every time the sealed refrigeration system is opened. Do not replace the drier until after all other repair or replacement has been made.

- 1) Disconnect the power source.
- 2) Remove the front panel.
- 3) Recover the refrigerant and store it in a proper container, if required by an applicable law (See "1. [b] REFRIGERANT RECOVERY").
- 4) Remove the drier using brazing equipment.
- 5) Install the new drier with the arrow on the drier in the direction of the refrigerant flow. Use nitrogen gas at the pressure of 0.2 - 0.3 bar when brazing the tubings.
- 6) Check for leaks using nitrogen gas (10 bar) and soap bubbles.
- 7) Evacuate the system, and charge it with refrigerant. See the nameplate for the required refrigerant charge (See "1. [c] EVACUATION AND RECHARGE").
- 8) Refit the front panel in its correct position.
- 9) Connect the power source.

5. EXPANSION VALVE

IMPORTANT

Sometimes moisture in the refrigerant circuit exceeds the drier capacity and freezes up at the expansion valve. Always install a new drier every time the sealed refrigeration system is opened. Do not replace the drier until after all other repair or replacement has been made.

- 1) Disconnect the power source.
- 2) Remove the front panel.
- 3) Recover the refrigerant and store it in a proper container, if required by an applicable law (See "1. [b] REFRIGERANT RECOVERY").
- 4) Remove the expansion valve bulb at the evaporator outlet.
- 5) Remove the expansion valve cover, and disconnect the expansion valve using brazing equipment.
- 6) Braze the new expansion valve with nitrogen gas flowing at the pressure of 0.2 - 0.3 bar.

WARNING

Always protect the valve body by using a damp cloth to prevent the valve from overheating. Do not braze with the valve body exceeding 120°C.

- 7) Install the new drier (See "4. DRIER").
- 8) Check for leaks using nitrogen gas (10 bar) and soap bubbles.
- 9) Evacuate the system, and charge it with refrigerant. See the nameplate for the required refrigerant charge (See "1. [c] EVACUATION AND RECHARGE").
- 10) Attach the bulb to the suction line. Be sure to secure the bulb using a wire or clamp and replace the insulation.
- 11) Place the new set of expansion valve covers in position.
- 12) Refit the front panel in its correct position.
- 13) Connect the power source.

6. WATER REGULATING VALVE - WATER-COOLED MODEL ONLY

IMPORTANT

Always install a new drier every time the sealed refrigeration system is opened. Do not replace the drier until after all other repair or replacement has been made.

- 1) Unplug the icemaker.
- 2) Close the water supply tap.
- 3) Remove the panels.
- 4) Recover the refrigerant and store it in a proper container, if required by an applicable law.
- 5) Disconnect the capillary tube using brazing equipment.
- 6) Disconnect the flare-connections of the valve.
- 7) Remove the screws and the valve from the bracket.
- 8) Install the new valve, and braze the capillary tube.
- 9) Install the new drier.
- 10) Check for leaks using nitrogen gas (10 bar) and soap bubbles.
- 11) Connect the flare-connections.
- 12) Evacuate the system, and charge it with refrigerant. See the nameplate for the required refrigerant charge.
- 13) Open the water supply tap.
- 14) Plug in the icemaker.
- 15) Check for water leaks.
- 16) If necessary, adjust the valve.
- 17) Replace the panels in position.

7. EVAPORATOR ASSEMBLY

See the exploded view under "III. 3. ICEMAKING MECHANISM".

- 1) Push the stop button to drain the water in the evaporator.
- 2) Disconnect the power source.
- 3) Remove the panels.
- 4) Remove the three thumbscrews, and take off the spout from the evaporator.
- 5) Remove the bin control switch.
- 6) Remove the spout gasket at the top of the evaporator.

CUTTER

- 7) Remove the bolt and lift off the cutter.

BELT HEATER

- 8) Detach the spring, and remove the belt heater.

EXTRUDING HEAD

- 9) Remove the sealing bolts, and lift off the extruding head.
- 10) Check the bearing inside the extruding head. If it is worn out or scratched, replace the bearing.

Note: Replacing the bearing needs a fitting tool. If it is not available, replace the whole extruding head.

AUGER

- 11) Lift out the auger. Check the top and bottom areas in contact with the bearings. If the surface is scratched or pitted, replace the auger. Check the blade edge of the auger. If it is scratched or worn where it has contacted the evaporator, replace it.

EVAPORATOR

Note: Skip the following steps 12) through 18) when the evaporator does not need replacement.

- 12) Recover the refrigerant and store it in a proper container, if required by an applicable law (See "1. [b] REFRIGERANT RECOVERY").

IMPORTANT

Always install a new drier every time the sealed refrigeration system is opened. Do not replace the drier until after all other repair or replacement has been made.

- 13) Remove the bulb of the expansion valve.
- 14) Disconnect the brazing connections of the expansion valve and the copper tube - low side from the evaporator, using brazing equipment.

WARNING

Always protect the valve body by using a damp cloth to prevent the valve from overheating. Do not braze with the valve body exceeding 120°C.

- 15) Remove the two truss head machine screws and the strap securing the evaporator.
- 16) Disconnect the hoses from the evaporator.
- 17) Remove the four socket head cap screws securing the evaporator with the housing.
- 18) Lift off the evaporator.

HOUSING AND MECHANICAL SEAL

- 19) The mechanical seal consists of two parts. One part rotates with the auger, the other is static and is fitted into a top recess in the housing. If the contact surfaces of these two parts become worn or scratched, the mechanical seal may leak water and should be replaced.
- 20) Remove the O-ring on the top outer edge of the housing.
- 21) Remove the four bolts and lift the housing clear of the gear motor. Check the bearing inside the housing. If it is worn or scratched, replace it using a fitting tool. Carefully ease out the lower part of the mechanical seal before replacing the bearing.

Note: If a fitting tool is not available, replace the whole lower housing complete with bearing.

GEAR MOTOR

- 22) Cut the connectors.
- 23) Remove the three socket head cap screws securing the gear motor.
- 24) Assemble the removed parts in the reverse order of which they were removed.

WARNING

Be careful not to scratch the surface of the O-ring, or it may cause water leaks. Handle the mechanical seal with care not to scratch nor to contaminate its contact surface.

25) When replacing the evaporator;

- (a) Braze the new evaporator with nitrogen gas flowing at the pressure of 0.2 - 0.3 bar.
- (b) Replace the drier.
- (c) Check for leaks using nitrogen gas (10 bar) and soap bubbles.
- (d) Evacuate the system, and charge it with refrigerant. See the nameplate for the required refrigerant charge (See "1. [c] EVACUATION AND RECHARGE").

26) Refit the panels in their correct position.

27) Connect the power source.

8. CONTROL WATER VALVE

- 1) Disconnect the power source.
- 2) Close the water supply tap.
- 3) Remove the panels.
- 4) Disconnect the terminals from the control water valve.
- 5) Remove the cover - reservoir Inlet from the control water valve.
- 6) Loosen the fitting nut on the control water valve Inlets, and remove the control water valve. Do not lose the packings inside the fitting nut.
- 7) Install the new control water valve.
- 8) Assemble the removed parts in the reverse order of which they were removed.
- 9) Open the water supply tap.
- 10) Connect the power source.
- 11) Check for water leaks.
- 12) Refit the panels in their correct position.

9. FLUSH WATER VALVE

- 1) Push the stop button, and after 5 minutes disconnect the power source.
- 2) Close the water supply tap.
- 3) Remove the panels.
- 4) Remove the clamp and disconnect the hose from the flush water valve.

Note: Water may still remain inside the evaporator. Be sure to drain the water into the drain pan.

- 5) Disconnect the terminals from the flush water valve.
- 6) Remove the flush water valve from the bracket.
- 7) Remove the drain pipe from the flush water valve.
- 8) Connect the drain pipe to the new flush water valve, and place the valve in position.
- 9) Connect the hose to the flush water valve, and secure it with the clamp.

- 10) Pour water into the reservoir, and check for water leaks on the flush water valve.
- 11) Open the water supply tap.
- 12) Connect the power source.
- 13) Check for water leaks.
- 14) Push the stop button, and make sure water is flushing.
- 15) Push the ice button.
- 16) Refit the panels in their correct position.

10. CONTROLLER BOARD

IMPORTANT

A single type controller board is supplied as a service board. Some modifications and adjustment will be required to fit the icemaker models. Do not repair any parts and electronic devices on the controller board in the field. Replace the whole board with a new service board.

[a] MODIFICATION

- 1) Check that the service board package includes:
Controller board 1 pc. Instruction sheet 1 pc.
- 2) Modify the service board referring to the instruction sheet attached (Set the model number according to "III. 5. [b] SETTING MODEL NUMBER").

[b] REPLACEMENT

- 1) Disconnect the power source.
- 2) Remove the front panel.
- 3) Remove screws and the control box cover.
- 4) Disconnect the connectors and board support from the controller board.
- 5) Remove the controller board from the control box.
- 6) Install the new controller board and reassemble the control box in the reverse order of the removal procedure.
- 7) Replace the front panel in its correct position.
- 8) Connect the power source.